



CE EMC Test Report

Issued date: Dec. 06, 2024

Project No.: 24Q101106

Product : Rugged Embedded System

Model : ABP-4000

Series Model : ABP-4000 Series, ABP-4XXXXXXXXXX ("X" can be 0-9, A-Z or blank)

Applicant : Vecow Co., Ltd

Address : 3F, No. 10, Jiankang Rd., Zhonghe Dist., New Taipei City 23586, Taiwan

Report No: WD-EE-R-240374-B0

According to

EN 50121-1: 2017

EN 50121-3-2: 2016

EN 50155:2021, Clause 13.4.9

EN 61000-3-2:2014, Class A

EN IEC 61000-3-2:2019 + A1:2021, Class A

EN 61000-3-3: 2013 + A1:2019 + A2:2021

EN 61000-4-2: 2009

EN IEC 61000-4-3: 2020

EN 61000-4-4: 2012

EN 61000-4-5: 2014 + A1: 2017

EN IEC 61000-4-6: 2023

Authorized Signatory :  / Ken Huang

Wendell Industrial Co., Ltd
Wendell EMC & RF Laboratory

Add: 5F-1, No. 188, Baoqiao Road, Xindian District, New Taipei City 23145, Taiwan R.O.C.



Table of Contents

1	Certification	6
1.1	Summary of Result.....	7
2	Laboratory Information.....	8
2.1	Measurement / Test Facility	8
2.2	Measurement Uncertainty	9
2.2.1	Conducted Emission Measurement	9
2.2.2	Radiated Emission Measurement.....	9
3	General Information.....	10
3.1	Description of Equipment Under Test	10
3.2	Description of Measurement / Test Modes	10
3.3	Description of Operating Condition	11
3.4	Description of Associated Equipment.....	12
3.5	Configuration of Equipment Under Test.....	13
4	Emission Measurement	14
4.1	Conducted Emission Measurement	14
4.1.1	Limit of Conducted Emission Measurement	14
4.1.2	Measurement Instrument	14
4.1.3	Measurement Procedure	16
4.1.4	Deviation from Standard.....	16
4.1.5	Measurement Configuration	17
4.1.6	Measurement Result	18
4.1.7	Photographs of Measurement Configuration	20
4.2	Radiated Emission Measurement	21
4.2.1	Limit of Radiated Emission Measurement	21
4.2.2	Measurement Instrument	22
4.2.3	Measurement Procedure	23
4.2.4	Deviation from Standard.....	23
4.2.5	Measurement Configuration	24
4.2.6	Measurement Result	27
4.2.7	Photographs of Measurement Configuration	31
4.3	Harmonic Current Measurement	33
4.3.1	Limit of Harmonic Current Measurement	33
4.3.2	Measurement Instrument	33
4.3.3	Measurement Procedure	34
4.3.4	Deviation from Standard.....	35
4.3.5	Measurement Configuration	35
4.3.6	Measurement Result	36
4.3.7	Photographs of Measurement Configuration	37
4.4	Voltage Fluctuations and Flicker Measurement.....	38
4.4.1	Limit for Voltage Functions and Flicker Measurement	38
4.4.2	Measurement Instrument	38
4.4.3	Measurement Procedure	38
4.4.4	Deviation from Standard.....	38
4.4.5	Measurement Configuration	39



4.4.6 Measurement Result 40

4.4.7 Photographs of Measurement Configuration 41

5 Immunity Test 42

5.1 Standard Description 42

5.2 Performance Criteria 43

5.3 Electrostatic Discharge Immunity Test 44

5.3.1 Test Specification..... 44

5.3.2 Test Instrument 44

5.3.3 Test Procedure..... 45

5.3.4 Deviation from Standard..... 46

5.3.5 Test Configuration 46

5.3.6 Test Result 48

5.3.7 Photographs of Test Configuration 53

5.4 Radiated, Radio-frequency Electromagnetic Field Immunity Test 54

5.4.1 Test Specification..... 54

5.4.2 Test Instrument 55

5.4.3 Test Procedure..... 56

5.4.4 Deviation from Standard..... 57

5.4.5 Test Configuration 57

5.4.6 Test Result 58

5.4.7 Photographs of Test Configuration 59

5.5 Electrical Fast Transient /Burst Immunity Test 60

5.5.1 Test Specification..... 60

5.5.2 Test Instrument 60

5.5.3 Test Procedure..... 61

5.5.4 Deviation from Standard..... 61

5.5.5 Test Configuration 62

5.5.6 Test Result 63

5.5.7 Photographs of Test Configuration 64

5.6 Surge Immunity Test 65

5.6.1 Test Specification..... 65

5.6.2 Test Instrument 65

5.6.3 Test Procedure..... 66

5.6.4 Deviation from Standard..... 66

5.6.5 Test Configuration 67

5.6.6 Test Result 68

5.6.7 Photographs of Test Configuration 69

5.7 Conducted Disturbances Immunity Test..... 70

5.7.1 Test Specification..... 70

5.7.2 Test Instrument 70

5.7.3 Test Procedure..... 71

5.7.4 Deviation from Standard..... 71

5.7.5 Test Configuration 72

5.7.6 Test Result 73

5.7.7 Photographs of Test Configuration 74



History of this test report

Report No.	Issue date	Description
WD-EE-R-240374-B0	Dec. 06, 2024	Initial Issue

Declaration

This report is for your exclusive use. Any copying or replication of this report to or for any other person or entity, or use of our name or trademark, is permitted only with our prior written permission. This report sets forth our findings solely with respect to the test samples identified herein. The results set forth in this report are not indicative or representative of the quality or characteristics of the lot from which a test sample was taken or any similar or identical product unless specifically and expressly noted. Our report includes all of the tests requested by you and the results thereof based upon the information that you provided to us.



History of supplementary report

Report No.	Issue date	Description
WD-EE-R-240374-B0	Dec. 06, 2024	Original report

Declaration

This report is for your exclusive use. Any copying or replication of this report to or for any other person or entity, or use of our name or trademark, is permitted only with our prior written permission. This report sets forth our findings solely with respect to the test samples identified herein. The results set forth in this report are not indicative or representative of the quality or characteristics of the lot from which a test sample was taken or any similar or identical product unless specifically and expressly noted. Our report includes all of the tests requested by you and the results thereof based upon the information that you provided to us.



1 Certification

Product: Rugged Embedded System
Brand Name: Vecow
Model: ABP-4000
Series Model: ABP-4000 Series, ABP-4XXXXXXXXXXXX ("X" can be 0-9, A-Z or blank)
Applicant: Vecow Co., Ltd
Tested: Oct. 21 ~ Dec. 02, 2024
Standard: EN 50121-1: 2017
EN 50121-3-2: 2016
EN 50155:2021, Clause 13.4.9
EN 61000-3-2:2014, Class A
EN IEC 61000-3-2:2019 + A1:2021, Class A
EN 61000-3-3: 2013 + A1:2019 + A2:2021
EN 61000-4-2: 2009
EN IEC 61000-4-3: 2020
EN 61000-4-4: 2012
EN 61000-4-5: 2014 + A1: 2017
EN IEC 61000-4-6: 2023

The above equipment (Model: ABP-4000) has been tested by **Wendell EMC & RF Laboratory**, and found compliance with the requirement of the above standards. The test record, data evaluation and Equipment Under Test (EUT) configurations represented herein are true and accurate accounts of the measurements of the sample's EMC characteristics under the conditions specified in this report.

Please note that the measurement uncertainty are provided for informational purpose only and are not used in determining the Pass/Fail results.

1.1 Summary of Result

The EUT has been tested according to the following specifications:

Emission			
Basic Standard	Test Item	Result	Remark
EN 55016-2-1	Conducted disturbance at mains terminals	Pass	Meets the requirements
EN IEC 61000-6-4	Radiated disturbance	Pass	Meets the requirements
EN 61000-3-2	Harmonic current emissions	Pass	The power consumption of EUT is less than 75W and no limits apply
EN 61000-3-3	Voltage fluctuations and flicker	Pass	Meets the requirements

Immunity			
Basic Standard	Test Item	Result	Remark
EN 61000-4-2	Electrostatic discharge	Pass	Meets the requirements of Performance Criterion B
EN IEC 61000-4-3	Radiated, radio-frequency electromagnetic field	Pass	Meets the requirements of Performance Criterion A
EN 61000-4-4	Electrical fast transient / burst	Pass	Meets the requirements of Performance Criterion A
EN 61000-4-5	Surge	Pass	Meets the requirements of Performance Criterion A
EN IEC 61000-4-6	Conducted disturbances	Pass	Meets the requirements of Performance Criterion A

Note: Test record contained in the referenced test report relate only to the EUT sample and test item.

2 Laboratory Information

2.1 Measurement / Test Facility

Conducted disturbance at main power port, Conducted disturbance at telecommunication port, Harmonics, Flicker, ESD, EFT, Surge, CS, PFMF, DIP and Close Proximity Radiated fields test

W01: 5F-1, No.188, Baoqiao Rd., Xindian Dist., New Taipei City 23145, Taiwan (R.O.C)

RS, ESD and Surge test

W05: 1F-7, No.188, Baoqiao Rd., Xindian Dist., New Taipei City 23145, Taiwan (R.O.C)

Conducted disturbance at main power port, Conducted disturbance at telecommunication port, Radiated disturbance (9*6*6 Chamber) and ESD test

W08: No.119, Wugong 3rd Rd., Wugu Dist., New Taipei City 248, Taiwan (R.O.C)

ACCREDITATIONS

The laboratories are accredited and approved by the TAF according to ISO/IEC 17025.

2.2 Measurement Uncertainty

The measurement instrumentation uncertainty is evaluated according to CISPR 16-4-2.

This uncertainty represents an expanded uncertainty expressed at approximately the 95% confidence level using a coverage factor of $k=2$.

Wendell EMC & RF Laboratory U_{lab} is less than U_{cispr} , therefore compliance or non-compliance with a disturbance limit shall be determined in the following manner.

- compliance is deemed to occur if no measured disturbance level exceeds the disturbance limit;
- non-compliance is deemed to occur if any measured disturbance level exceeds the disturbance limit.

Please note that the measurement uncertainty (U_{lab}) is provided for informational purpose only and is not used in determining the Pass/Fail results.

2.2.1 Conducted Emission Measurement

Test Site	Frequency Range	dB (U_{lab})	Note
W01-CE	150 kHz ~ 30 MHz	2.84	LISN
W08-CE	150 kHz ~ 30 MHz	2.72	LISN

2.2.2 Radiated Emission Measurement

Test Site	Frequency Range	Ant	dB (U_{lab})	Note
W08-966-1	30 MHz ~ 200 MHz	V	3.50	N/A
	30 MHz ~ 200 MHz	H	2.96	N/A
	200 MHz ~ 1000 MHz	V	5.09	N/A
	200 MHz ~ 1000 MHz	H	3.41	N/A
	1 GHz ~ 6 GHz	V	4.37	N/A
	1 GHz ~ 6 GHz	H	4.30	N/A

3 General Information

3.1 Description of Equipment Under Test

Product	Rugged Embedded System
Brand	Vecow
Model	ABP-4000
Series Model	ABP-4000 Series, ABP-4XXXXXXXXXX ("X" can be 0-9, A-Z or blank)
Applicant	Vecow Co., Ltd
Received Date	Oct. 15, 2024
EUT Power Rating	24Vdc (from adapter)
Model Differences	The models are electrically identical, different models no. are for marketing purpose. The series model information is provided by client.
Operating System	Windows 11 Pro version: 22H2
Data Cable Supplied	N/A
Accessory Device	N/A
I/O Port	Please refer to the User's Manual

Note:

- The EUT uses the follow adapter:

Adapter (support unit only)	
Brand	FSP
Model	FSP120-AAAN2
Input Power	100-240Vac, 1.8A, 50-60Hz
Output Power	24Vdc, 5A
Power line	Input: 1.8m non-shielded cable Output: 1.4m non-shielded cable with 1 core

- The EUT contains following components.

Item	Brand	Model	Spec.	Qty.
Main Board	-	ABP-4000	Rev. C	1
CPU	Intel	13th Gen Intel® Core™ i7-1365UE	1.70 GHz	1
RAM	Vecow	VMD4NIS-32G00C	32GB DDR4 3200 W/T SODIMM	2
M.2 SSD	innodisk	DEM28-C12DD1KWAQF-H03	M.2(P80) 3TE6 512GB	1

- The EUT's highest operating frequency is 1.7GHz. Therefore the radiated emission is tested up to 6GHz.

3.2 Description of Measurement / Test Modes

Test results are presented in the report as below.

Test Mode	Measurement / Test Condition
Conducted Emission Measurement	
-	AC-DC Adapter mode
Radiated Emission 30MHz ~ 1GHz Measurement	
-	AC-DC Adapter mode
Radiated Emission above 1GHz Measurement	
-	AC-DC Adapter mode
Harmonic & Flicker Measurement	
-	AC-DC Adapter mode
Immunity Test	
-	AC-DC Adapter mode

3.3 Description of Operating Condition

- The EUT placed on test table.
- Prepare PC to act as a communication partner and placed it outside of testing area.
- The EUT was connected to the PC with LAN cable.
- The communication partner sent data to EUT by command "ping" via LAN.
- The EUT read / write data with Internal SSD & External HDD/SSD.
- The EUT run test program BurnIN.exe to enable all functions
- The EUT sent Color Bar ITU-R.BT471-1 signal to monitor and displayed on screen.
- The microphone sent voice signal to EUT.
- The EUT sent voice signal to earphone.



3.4 Description of Associated Equipment

The EUT has been conducted testing with other necessary accessories or support units.

Item	Equipment	Brand	Model No.	Serial No.	FCC ID	Data Cable	Power Cable	Remark
1	Desktop PC	DELL	D19M	N/A	PPD-QCN FA335	20m CAT.5E non-shielded LAN cable	AC: 1.8m non-shielded cable	-
2	Desktop PC	DELL	D24M	N/A	PD93165NG	20m CAT.5E non-shielded LAN cable	AC: 1.8m non-shielded cable	-
3	4K monitor	PHILIPS	276E8V	UKC19260004 58	FCC DoC Approved	1.5m shielded HDMI cable	AC: 1.8m non-shielded cable DC: 1.4m non-shielded cable with 1 core	-
4	4K monitor	HP	HP 27f 4k Display	3CM01935TF	FCC DoC Approved	1.5m shielded HDMI cable with 2 cores	AC: 1.8m non-shielded cable DC: 1.4m non-shielded cable with 1 core	-
5	4K Monitor	ASUS	XG27UCS	S5LMTF2007 65	FCC SDoC Approved	1.5m shielded HDMI cable with 2 cores	AC: 1.8m non-shielded cable	-
6	4K Monitor	ASUS	XG27UCS	S7LMT011954	FCC SDoC Approved	1.5m shielded HDMI cable	AC: 1.8m non-shielded cable	-
7	Keyboard	DELL	KB216t	CN-0W33XP- L0300 -7C1-15UP	FCC SDoC Approved	1.5m non-shielded USB cable	N/A	-
8	Mouse	DELL	MS116	CN-0DV0RH- L0300 -7C1-15UP	FCC SDoC Approved	1.5m non-shielded USB cable	N/A	-
9	Earphone & Microphone	Avier	AEP-MM	N/A	N/A	1.2m non-shielded audio cable	N/A	-
10	External Hard Drive (x2)	Transcend	TS1T5J25C 3N	D62397-0399	FCC SDoC Approved	1m shielded USB cable	N/A	-
11	External Portable SSD	Transcend	TS120GES D240C	F96474-0001	FCC SDoC Approved	1m shielded USB cable	N/A	-
12	RS232 terminator (x2)	N/A	N/A	N/A	N/A	N/A	N/A	Supplied by client

- Note:**
1. The core(s) is(are) originally attached to the cable(s).
 2. Item 1-2 acted as communication partners to transfer data.

3.5 Configuration of Equipment Under Test

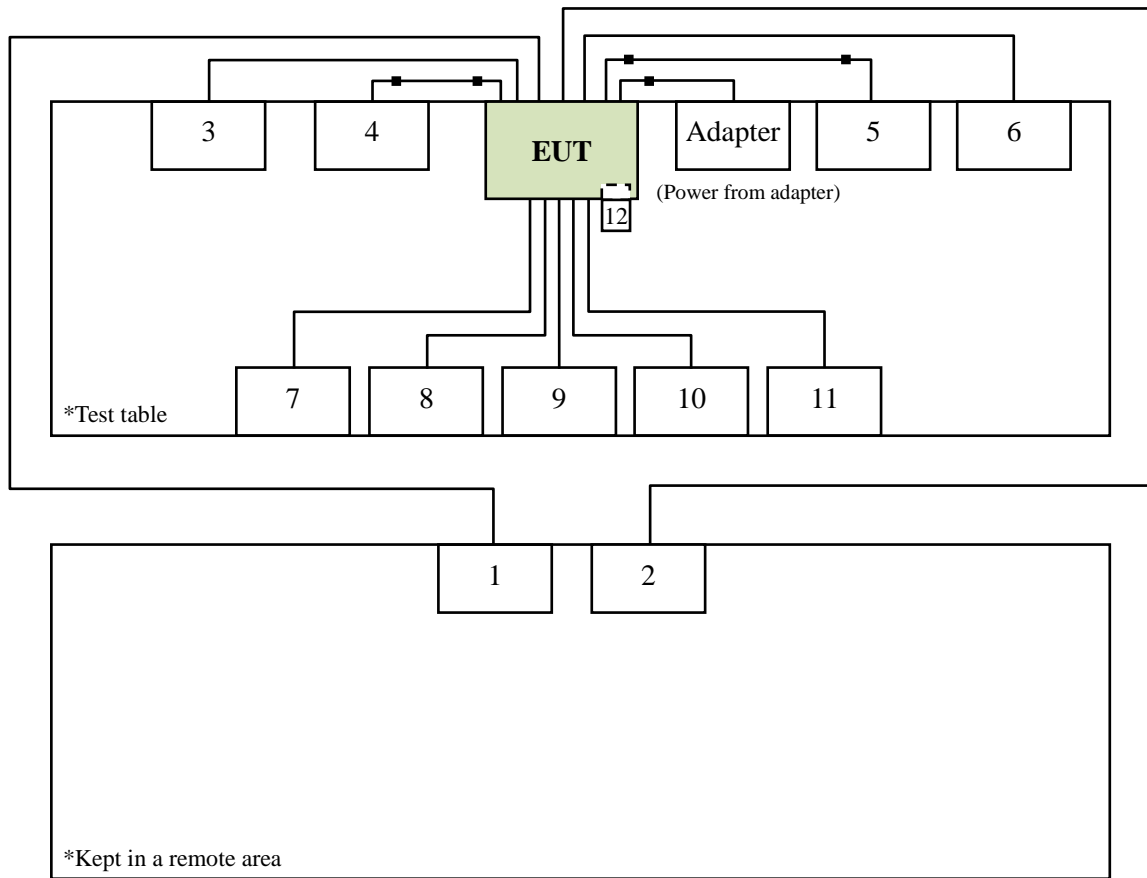

4 Emission Measurement

4.1 Conducted Emission Measurement

4.1.1 Limit of Conducted Emission Measurement

Frequency (MHz)	Quasi-peak dB(μV)
0.15 to 0.5	99
0.5 to 30	93

- Note:**
- The lower limit shall apply at the transition frequencies.
 - Detector function in the form: QP = Quasi Peak, AVG = Average
 - The result calculated as following:
 Measurement Value = Reading Level + Correct Factor
 Correct Factor = LISN Factor + Cable Loss + Transient Limiter (If use)
 Margin Level = Measurement Value – Limit Value

4.1.2 Measurement Instrument

Test Site: W01-CE					
Item	Equipment	Manufacturer	Model	Meter No.	Calibration Date
1	TWO-LINE V-NETWORK	R&S	ENV216	CT-1-025-1	Jun. 05, 2024
2	Pulse limiter	R&S	ESH3-Z2	CT-2-015	Jun. 06, 2024
3	EMI Test Receiver	R&S	ESCI	CT-1-024	Jun. 06, 2024
4	Artificial Mains Network (AMN)	SCHWARZBECK	NSLK 8127	CT-1-104-1	Jun. 06, 2024
5	RF Cable	MVE	200200.400LL .500A	CT-9-101	Jun. 06, 2024
6	50ohm Termination	N/A	N/A	CT-1-065-1	May 30, 2024
7	Measurement Software	EZ-EMC	Ver: EMC-CON 3A1	CT-3-012	No calibration request

- Note:** 1. The calibration interval of the above test instruments is 12 months.



Test Site: W08-CE					
Item	Equipment	Manufacturer	Model	Meter No.	Calibration Date
1	TWO-LINE V-NETWORK	R&S	ENV216	CT-1-025-2	Jun. 20, 2024
2	RF Cable	EMCI	EMCCFD300-BM-BM-5000	CT-1-107-2	Jun. 24, 2024
3	EMI Test Receiver	R&S	ESR3	CT-1-103	Jun. 20, 2024
4	Artificial Mains Network (AMN)	SCHWARZBECK	NSLK 8127 RC	CT-1-104-1R C	Jun. 20, 2024
5	Transient Limiter	Electro-Metrics	EM-7600	CT-1-026	Jun. 24, 2024
6	50ohm Termination	N/A	N/A	CT-1-109-1	Jun. 20, 2024
7	Measurement Software	EZ-EMC	Ver: EMC-CON 3A1	CT-3-012	No calibration request

Note: 1. The calibration interval of the above test instruments is 12 months.

4.1.3 Measurement Procedure

- a. The table-top equipment under test was placed 0.8 meter height wooden table from the horizontal ground plane with EUT being connected to power source through a line impedance stabilization network (LISN). The floor-standing equipment under test was placed insulation support unit from the horizontal ground plane. The LISN at least be 0.8 meter from nearest chassis of equipment under test.
- b. The line impedance stabilization network (LISN) provides 50 ohm/50uH of coupling impedance for the measuring instrument. All associated equipment powered from additional LISN(s).
- c. Interrelating cables that hang closer than 0.4 meter to the ground plane shall be folded back and forth in the center forming a bundle. All I/O cables were positioned to simulate typical usage.
- d. The loads and/or devices simulating typical operating conditions shall be connected to at least one of each type of interface port of the equipment under test. If loading (or terminating) with a device of actual usage is not feasible, the port should be loaded with a simulator. Where these options are not practical the port shall be loaded by the application of a typical impedance considering both the common and differential modes.
- e. The EMI test receiver connected to the line impedance stabilization network (LISN) powering the equipment. The measurements shall be limited to the operating ranges of voltage and frequency as specified for the equipment under test, having regard to the supply voltage and frequency for the intended market of the equipment under test.
- f. The EMI test receiver scanned from 150kHz to 30MHz for emissions in each of modes. A scan was taken on both power lines, Line and Neutral, recording at least six highest emission amplitude.
- g. The equipment under test and cable configuration of the above highest emission amplitude were recorded.

4.1.4 Deviation from Standard

No deviation

4.1.5 Measurement Configuration

< Table-Top equipment under test >

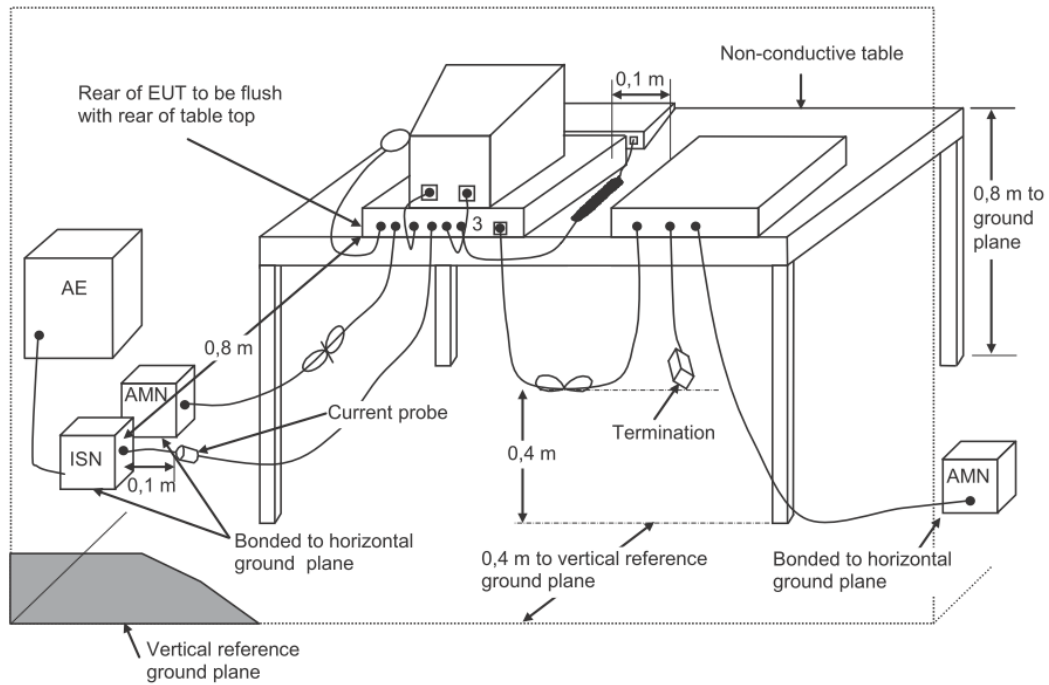

< Floor-Standing equipment under test >

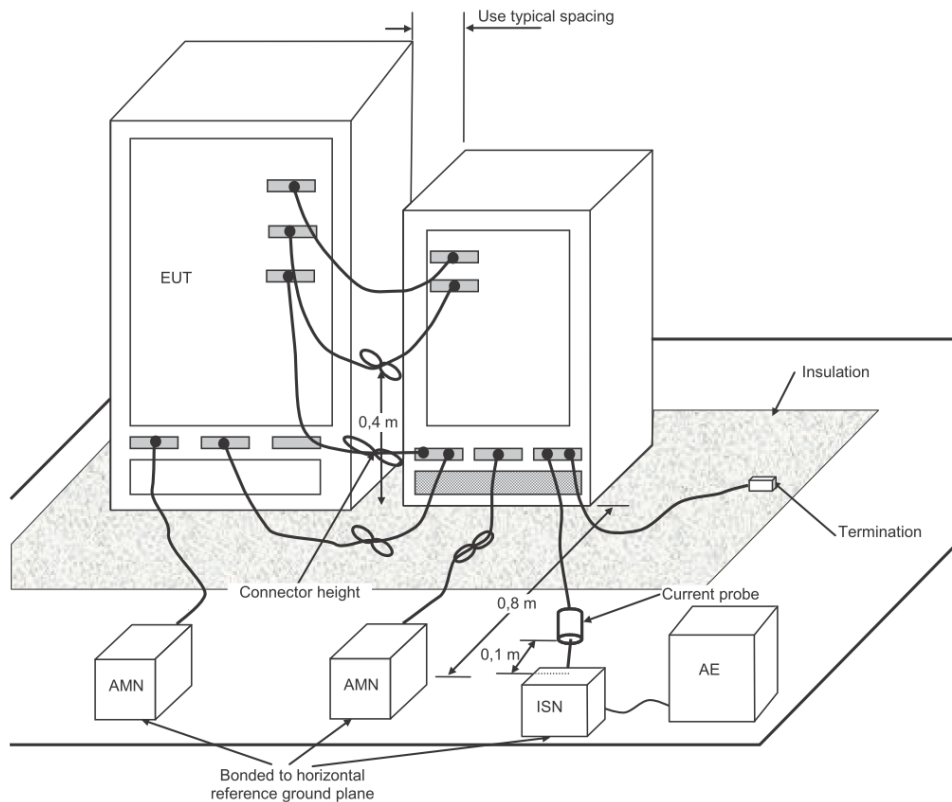

Note: Please refer to 4.1.7 for the actual test configuration.

4.1.6 Measurement Result

Test Voltage	230Vac, 50Hz	Frequency Range	0.15 ~ 30 MHz
Environmental Conditions	22°C, 51% RH	6dB Bandwidth	9 kHz
Test Date	2024/11/29	Phase	L
Tested by	Guanwei Liao	Test Site	W01-CE

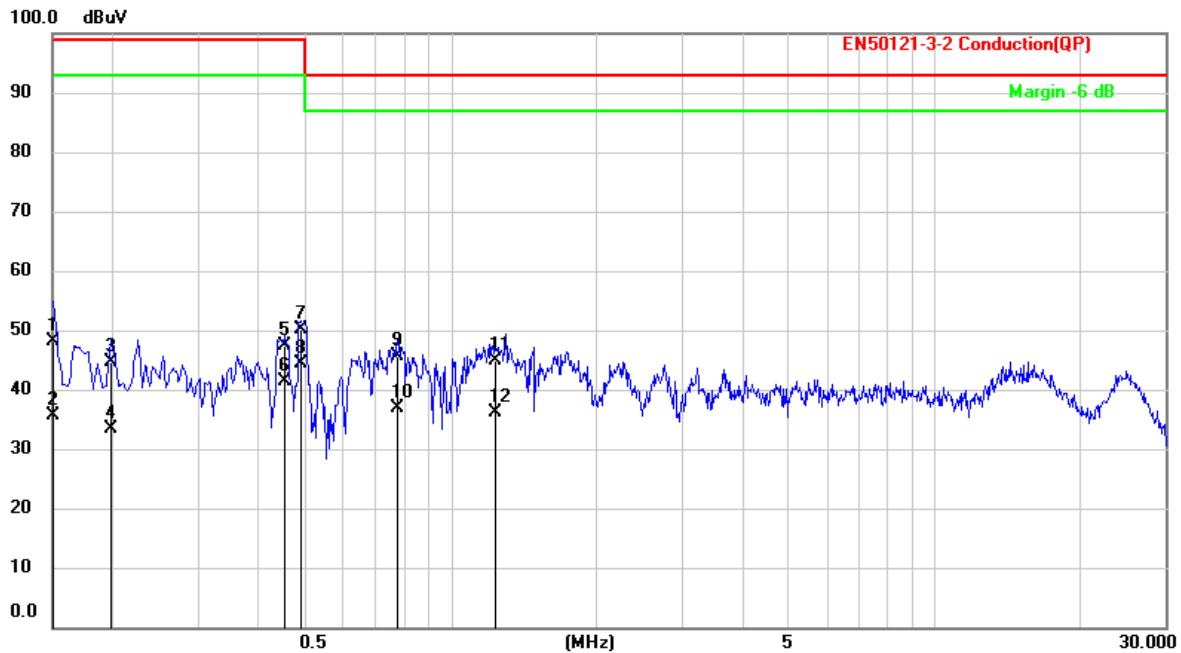

No.	Frequency (MHz)	Reading Level (dBµV)	Correct Factor (dB)	Measurement (dBµV)	Limit (dBµV)	Margin (dB)	Detector
1	0.1503	38.19	9.91	48.10	99.00	-50.90	QP
2	0.1503	25.83	9.91	35.74	99.00	-63.26	AVG
3	0.1992	34.81	9.92	44.73	99.00	-54.27	QP
4	0.1992	23.42	9.92	33.34	99.00	-65.66	AVG
5	0.4545	37.51	9.93	47.44	99.00	-51.56	QP
6	0.4545	31.40	9.93	41.33	99.00	-57.67	AVG
7	0.4913	40.26	9.93	50.19	99.00	-48.81	QP
8	0.4913	34.53	9.93	44.46	99.00	-54.54	AVG
9	0.7787	35.62	9.95	45.57	93.00	-47.43	QP
10	0.7787	27.04	9.95	36.99	93.00	-56.01	AVG
11	1.2361	34.82	9.95	44.77	93.00	-48.23	QP
12	1.2361	26.30	9.95	36.25	93.00	-56.75	AVG

Remark:

1. QP = Quasi Peak, AVG = Average
2. Correct Factor = LISN Factor + Cable Loss + Transient Limiter (If use)
3. Measurement Value = Reading Level + Correct Factor
4. Margin Level = Measurement Value - Limit Value



Test Voltage	230Vac, 50Hz	Frequency Range	0.15 ~ 30 MHz
Environmental Conditions	22°C, 51% RH	6dB Bandwidth	9 kHz
Test Date	2024/11/29	Phase	N
Tested by	Guanwei Liao	Test Site	W01-CE

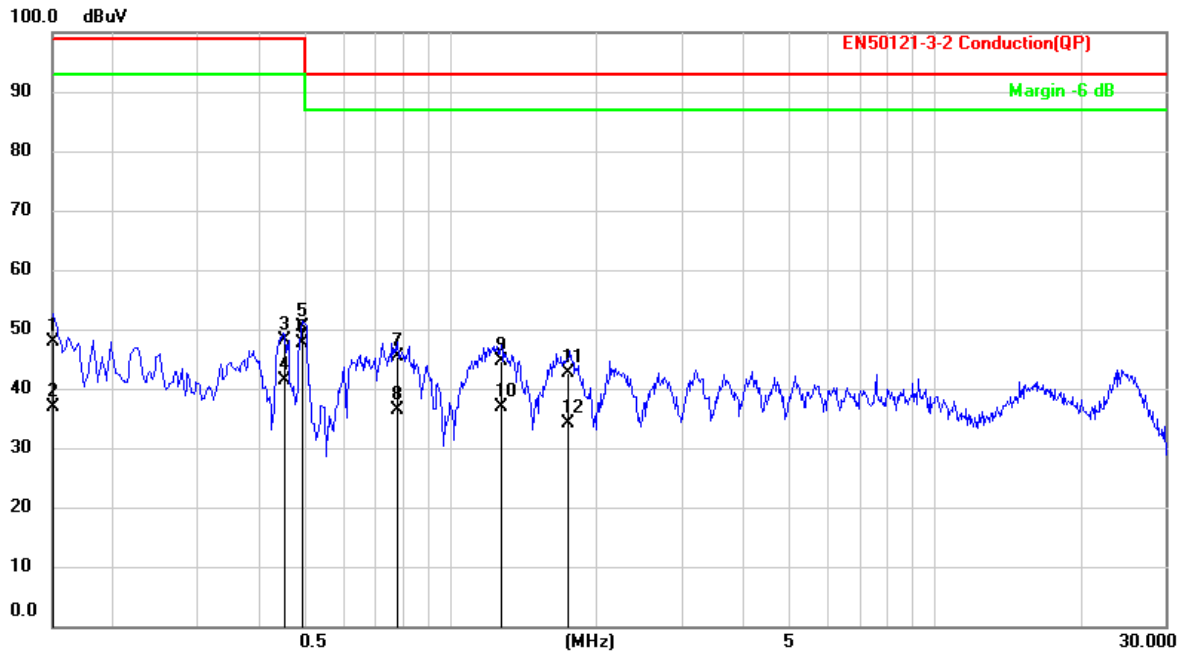

No.	Frequency (MHz)	Reading Level (dBμV)	Correct Factor (dB)	Measurement (dBμV)	Limit (dBμV)	Margin (dB)	Detector
1	0.1508	37.98	9.90	47.88	99.00	-51.12	QP
2	0.1508	27.09	9.90	36.99	99.00	-62.01	AVG
3	0.4544	38.10	9.91	48.01	99.00	-50.99	QP
4	0.4544	31.47	9.91	41.38	99.00	-57.62	AVG
5	0.4934	40.48	9.91	50.39	99.00	-48.61	QP
6	0.4934	37.67	9.91	47.58	99.00	-51.42	AVG
7	0.7771	35.35	9.93	45.28	93.00	-47.72	QP
8	0.7771	26.57	9.93	36.50	93.00	-56.50	AVG
9	1.2640	34.67	9.95	44.62	93.00	-48.38	QP
10	1.2640	26.85	9.95	36.80	93.00	-56.20	AVG
11	1.7432	32.60	9.95	42.55	93.00	-50.45	QP
12	1.7432	24.29	9.95	34.24	93.00	-58.76	AVG

Remark: 1. QP = Quasi Peak, AVG = Average
 2. Correct Factor = LISN Factor + Cable Loss + Transient Limiter (If use)
 3. Measurement Value = Reading Level + Correct Factor
 4. Margin Level = Measurement Value - Limit Value

4.1.7 Photographs of Measurement Configuration

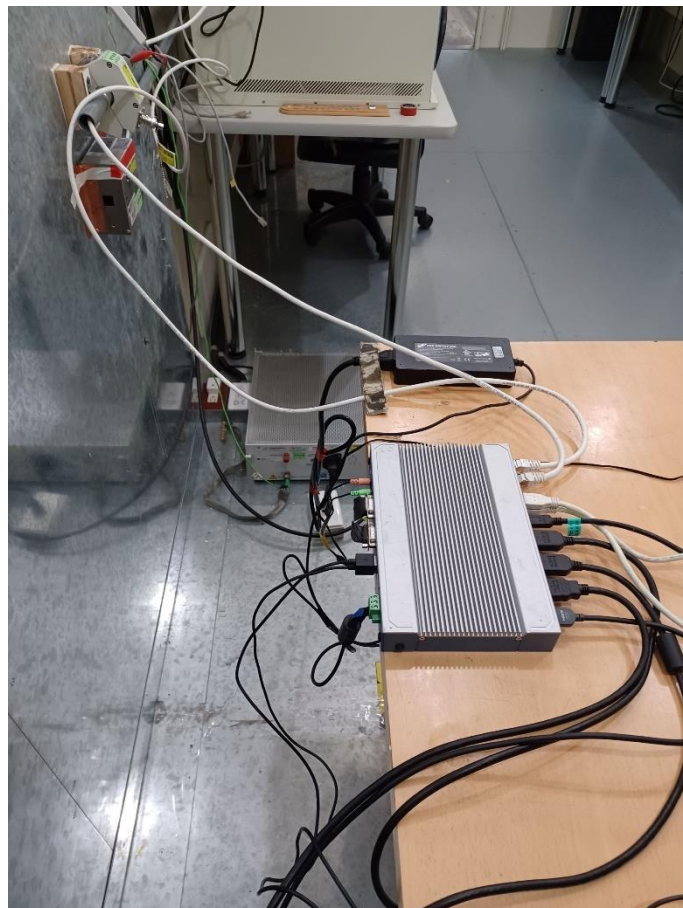
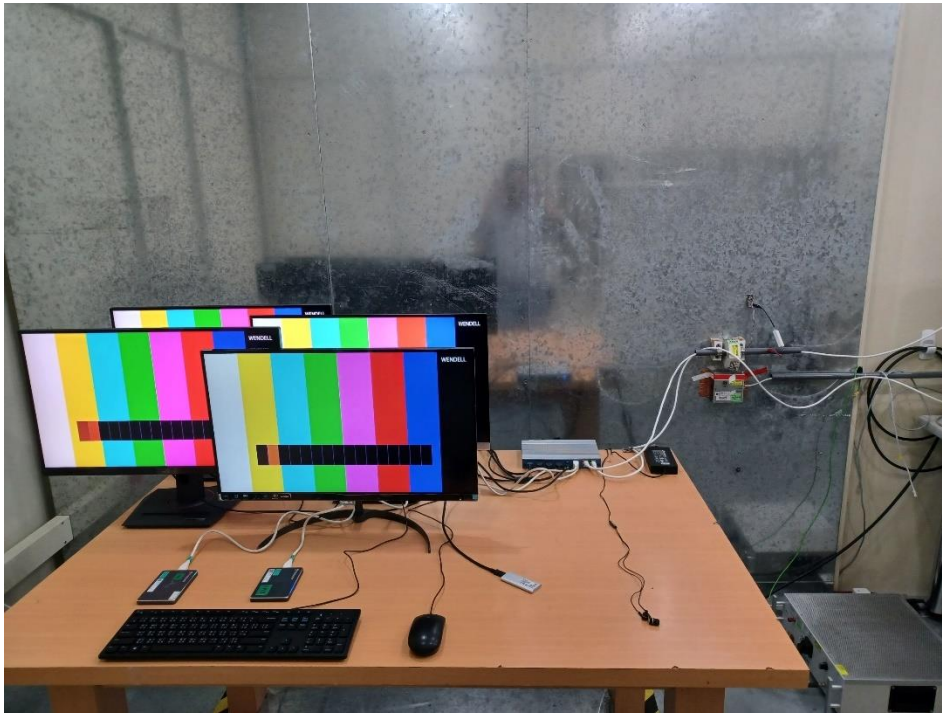

4.2 Radiated Emission Measurement

4.2.1 Limit of Radiated Emission Measurement

According to EN IEC 61000-6-4 table2 - Required highest frequency for radiated measurement:

Highest internal frequency (F_x)	Highest measured frequency
$F_x \leq 108$ MHz	1 GHz
108 MHz $< F_x \leq 500$ MHz	2 GHz
500 MHz $< F_x \leq 1$ GHz	5 GHz
$F_x > 1$ GHz	$5 \times F_x$ up to a maximum of 6 GHz

Remark:

1. F_x : highest fundamental frequency generated or used within the EUT or highest frequency at which it operates.
2. Where F_x is unknown, the radiated emission measurements shall be performed up to 6 GHz.

Radiated Frequency range 30 MHz to 1000 MHz

Frequency (MHz)	Quasi-peak dB(μ V/m) at 3m
30 to 230	50
230 to 1000	57

Radiated Frequency range above 1 GHz

Frequency (GHz)	Average dB(μ V/m) at 3m	Peak dB(μ V/m) at 3m
1 to 3	56	76
3 to 6	60	80

- Note:**
1. The lower limit shall apply at the transition frequency.
 2. Detector function in the form: PK = Peak, QP = Quasi Peak, AVG = Average
 3. The result calculated as following:
 Measurement Value = Reading Level + Correct Factor
 Correct Factor = Antenna Factor + Cable Loss (Antenna to Pre-Amplifier) -
 Pre-Amplifier Gain + Cable Loss (Pre-Amplifier to Receiver)
 Margin Level = Measurement Value - Limit Value



4.2.2 Measurement Instrument

Test Site: W08-966-1					
Item	Equipment	Manufacturer	Model	Meter No.	Calibration Date
1	Horn Antenna	Schwarzbeck	BBHA 9120D	CT-9-031	Jul. 29, 2024
2	Horn Antenna	Schwarzbeck	BBHA 9170	CT-9-032	Aug. 15, 2024
3	TRILOG Broadband Antenna with 6 dB Attenuator	Schwarzbeck & MVE	VULB 9168 & MVE2251-06	CT-1-096-1	May 06, 2024
4	Spectrum Analyzer	Agilent	E4407B	CT-1-003(1)	Aug. 08, 2024
5	EXA Signal Analyzer	Keysight	N9010A	CT-1-093	Aug. 18, 2024
6	EMI Test Receiver	Keysight	N9038A	CT-9-007	Aug. 09, 2024
7	Preamplifier	EM	EMC330	CT-9-024	Aug. 08, 2024
8	Preamplifier	SGH & MCL	SGH118 & BW-S15W2+	CT-9-071	Aug. 08, 2024
9	Preamplifier	EMCI	EMC184045SE	CT-9-013	Aug. 16, 2024
10	Test Cable	EMCI	EMCCFD400-NM-NM-1000	CT-1-132	Aug. 10, 2024
11	Test Cable	PEWC	CFD400NL-LW-NM-NM-3000	CT-1-141	Aug. 10, 2024
12	Test Cable	EMCI	EMCCFD400-NM-NM-15000	CT-1-133	Aug. 10, 2024
13	Test Cable	EMCI	EMC104-SM-35M-600	CT-1-134	Aug. 09, 2024
14	Test Cable	MVE	280280.LL266.1400	CT-9-106	Aug. 09, 2024
15	Test Cable	EMCI	EMC102-KM-KM-600	CT-1-136	Aug. 21, 2024
16	Measurement Software	EZ-EMC	Ver :WD-03A1-1	CT-3-012	No calibration request

Note: 1. The calibration interval of the above test instruments is 12 months.

4.2.3 Measurement Procedure

- a. The table-top equipment under test was placed on the top of a turntable 0.8 meter above the ground at 3 m 966 chamber. The floor-standing equipment under test was placed insulation support unit from the horizontal ground plane. The turntable was rotated 360 degrees to determine the position of the highest radiation emissions.
- b. The height of the antenna shall vary between 1 m to 4 m. Both vertical and horizontal polarizations of the antenna were set to make the measurement.
- c. The loads and/or devices simulating typical operating conditions shall be connected to at least one of each type of interface port of the equipment under test. If loading (or terminating) with a device of actual usage is not feasible, the port should be loaded with a simulator. Where these options are not practical the port shall be loaded by the application of a typical impedance considering both the common and differential modes.
- d. The initial step in collecting radiated emission data is a spectrum mode scanning the measurement frequency range.

Below 1GHz:

Reading in which marked as QP means measurements by using receiver mode with detector setting in RBW = 120 kHz.

If the spectrum mode measured peak value compliance with and lower than QP Limit, the equipment under test shall be deemed to meet QP Limits.

Above 1GHz:

Reading in which marked as Peak & AVG means measurements by using spectrum mode with setting in RBW = 1 MHz.

If the spectrum mode measured value compliance with the Peak Limits and lower than AVG Limits, the equipment under test shall be deemed to meet both Peak and AVG Limits.

- e. Emission frequency and amplitude were recorded, recording at least six highest emissions. The equipment under test and cable configuration of the above highest emission amplitude were recorded.

4.2.4 Deviation from Standard

No deviation

4.2.5 Measurement Configuration

< Radiated Emissions Frequency: 30 MHz to 1000 MHz >

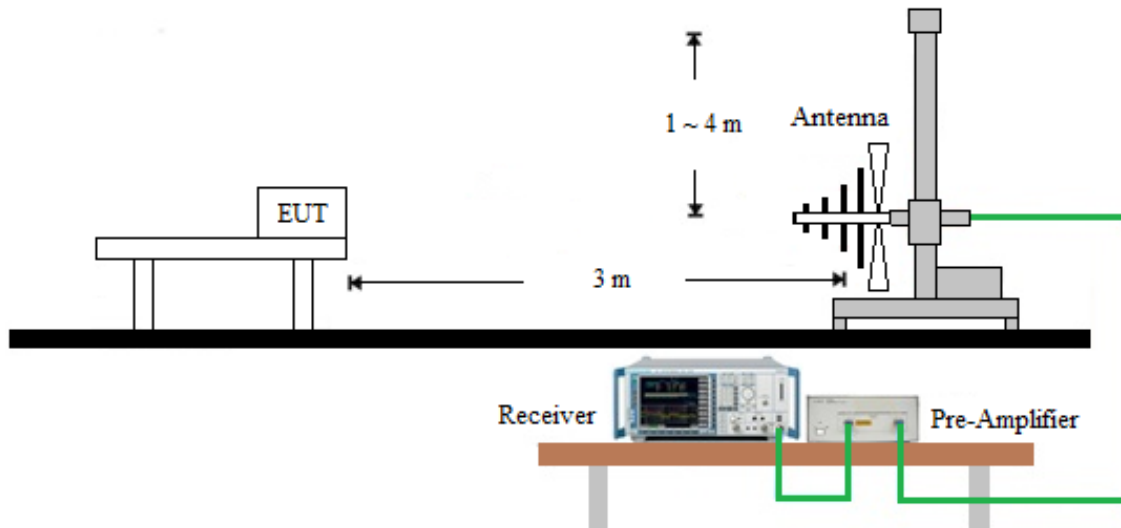

< Radiated Emissions Frequency: above 1GHz >

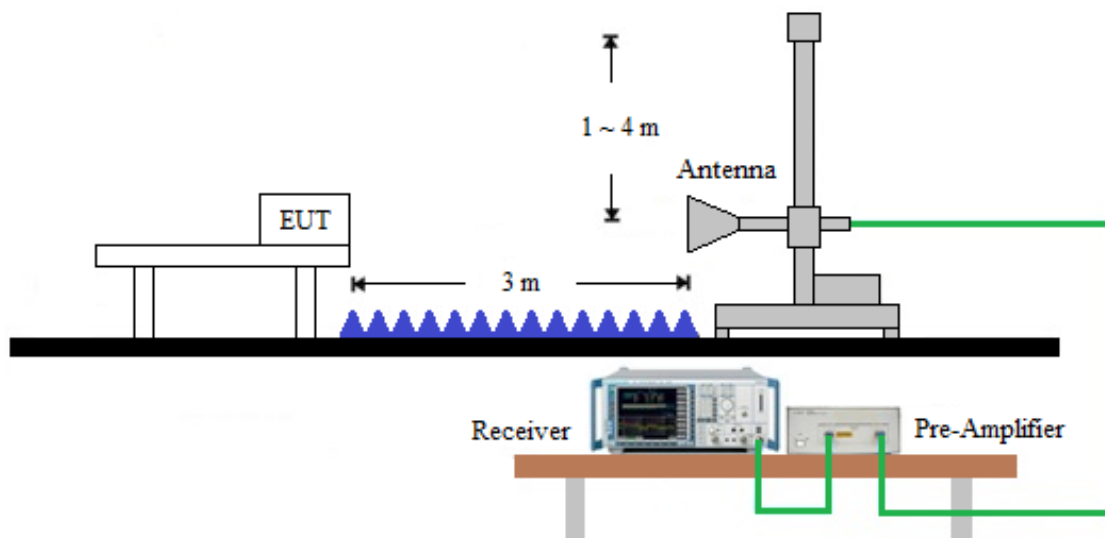

Note:

- (1) Please refer to the 4.3.7 for the actual test configuration.
- (2) Detector function in the form: PK = Peak, QP = Quasi Peak, AVG = Average
- (3) The test result calculated as following:
 Measurement Value = Reading Level + Correct Factor
 Correct Factor = Antenna Factor + Cable Loss – Pre-Amplifier Gain (if use)
 Margin Level = Measurement Value - Limit Value

< EUT placement top view and measurement distance >

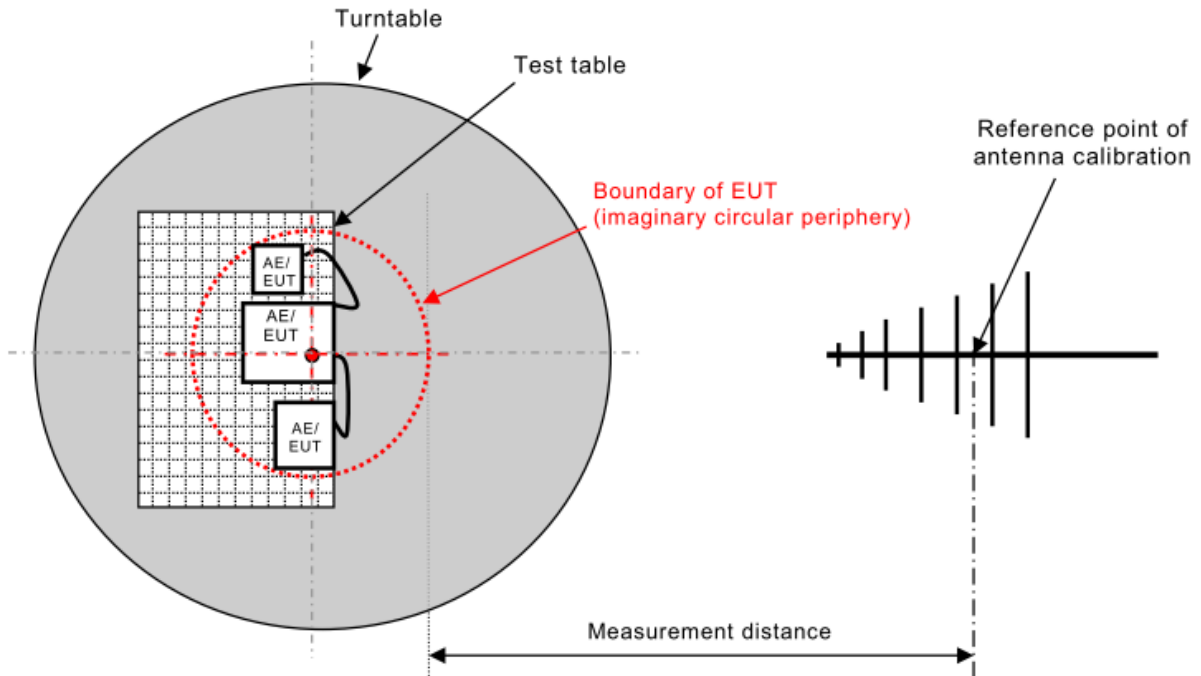

< Boundary of EUT, Local AE and associated cabling >

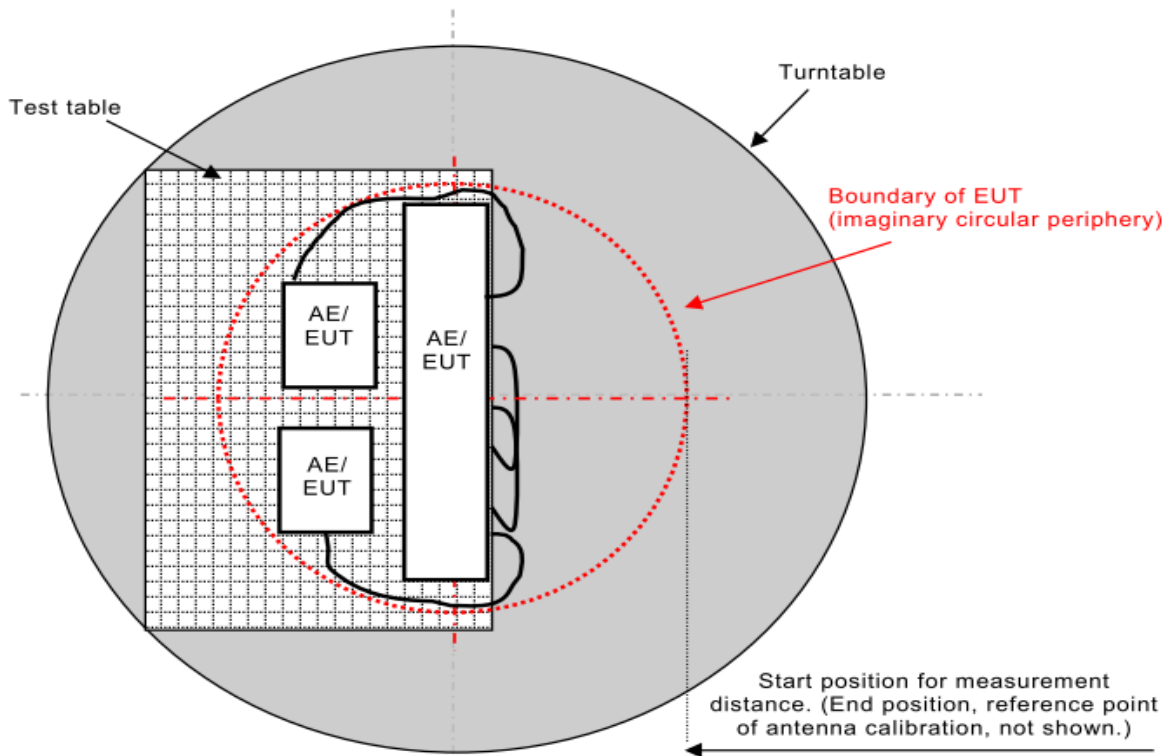

< Table-Top equipment under test >

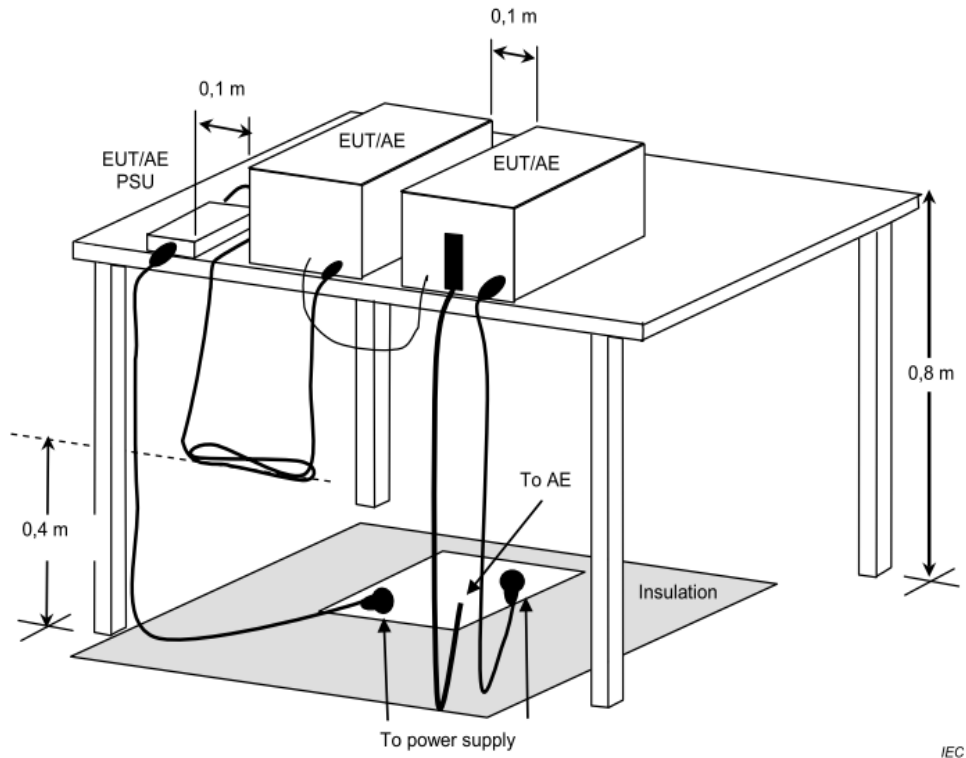

< Floor-Standing equipment under test >

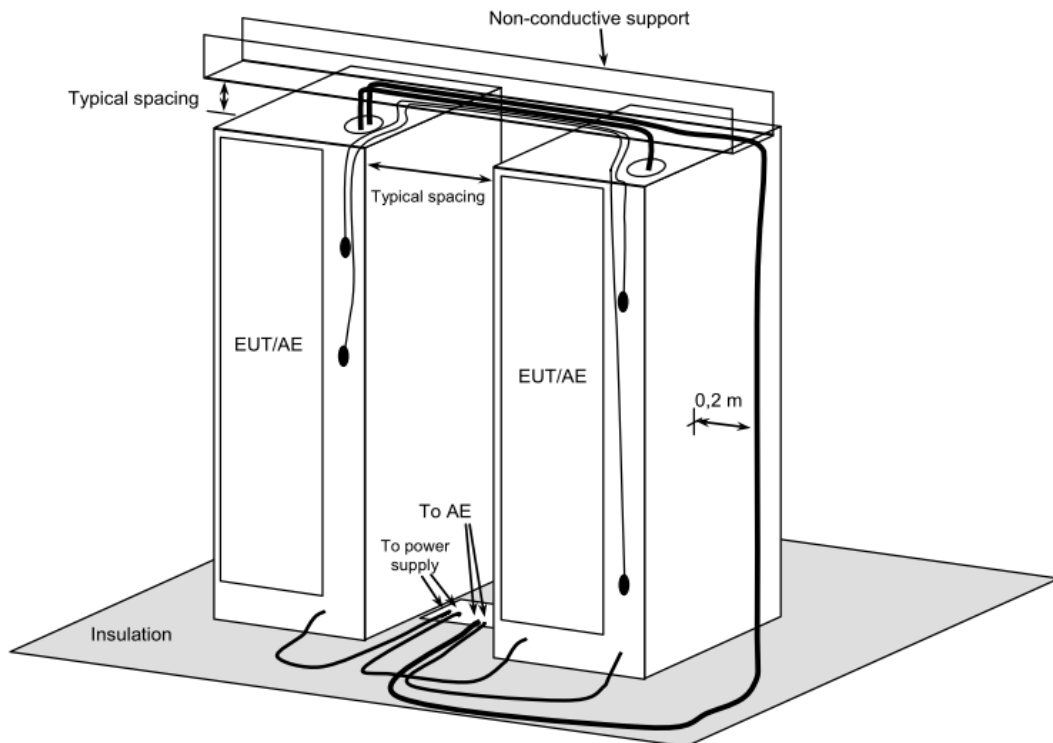

Note: Please refer to the 4.3.7 for the actual test configuration.



4.2.6 Measurement Result

Test Voltage	230Vac, 50Hz	Frequency Range	30 ~ 1000 MHz
Environmental Conditions	22°C, 50% RH	6dB Bandwidth	120 kHz
Test Date	2024/11/27	Test Distance	3m
Tested by	Karwin Kao	Polarization	Vertical
Test Site	W08-966-1		

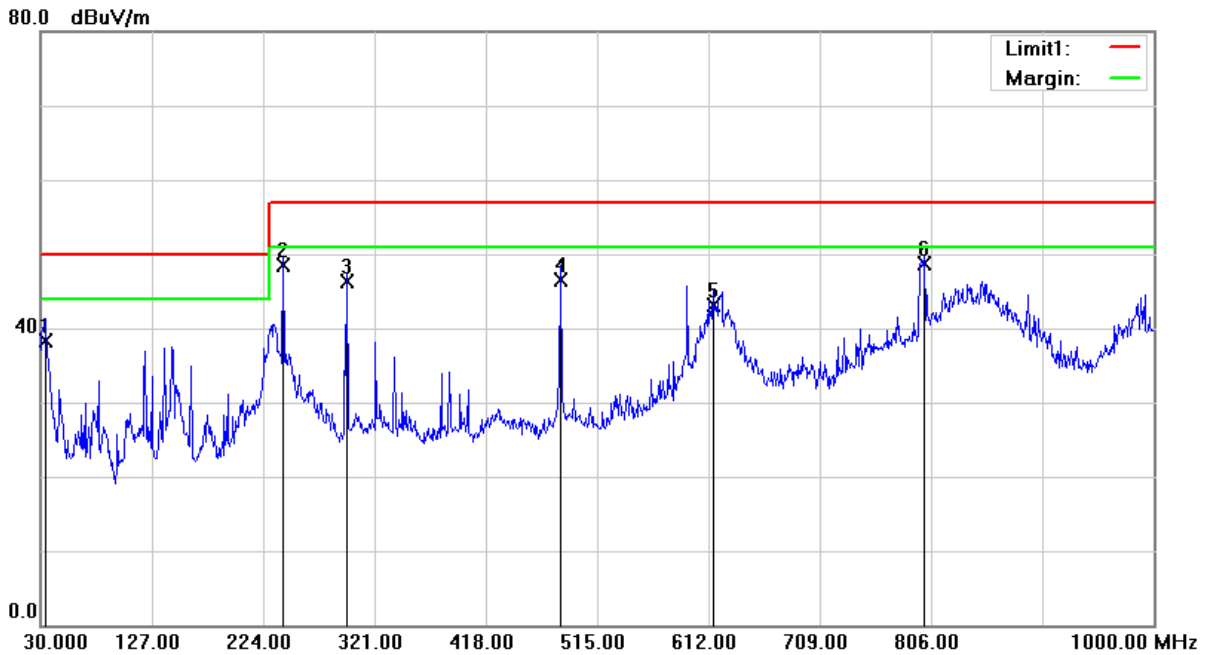

No.	Frequency (MHz)	Reading Level (dBμV)	Correct Factor (dB/m)	Measurement (dBμV/m)	Limit (dBμV/m)	Margin (dB)	Table Degree (degree)	Antenna Height (cm)	Detector
1	33.8800	49.35	-11.11	38.24	50.00	-11.76	218	100	QP
2	241.4600	59.18	-10.72	48.46	57.00	-8.54	351	200	QP
3	296.7500	54.69	-8.45	46.24	57.00	-10.76	19	200	QP
4	482.9900	49.78	-3.29	46.49	57.00	-10.51	279	100	QP
5	615.8800	42.82	0.36	43.18	57.00	-13.82	334	200	QP
6	800.1800	44.51	4.11	48.62	57.00	-8.38	16	200	QP

Remark: 1. QP = Quasi Peak
2. Correct Factor = Antenna Factor + Cable Loss (Antenna to Pre-Amplifier) – Pre-Amplifier Gain + Cable Loss (Pre-Amplifier to Receiver)
3. Measurement Value = Reading Level + Correct Factor
4. Margin Level = Measurement Value – Limit Value



Test Voltage	230Vac, 50Hz	Frequency Range	30 ~ 1000 MHz
Environmental Conditions	22°C, 50% RH	6dB Bandwidth	120 kHz
Test Date	2024/11/27	Test Distance	3m
Tested by	Karwin Kao	Polarization	Horizontal
Test Site	W08-966-1		

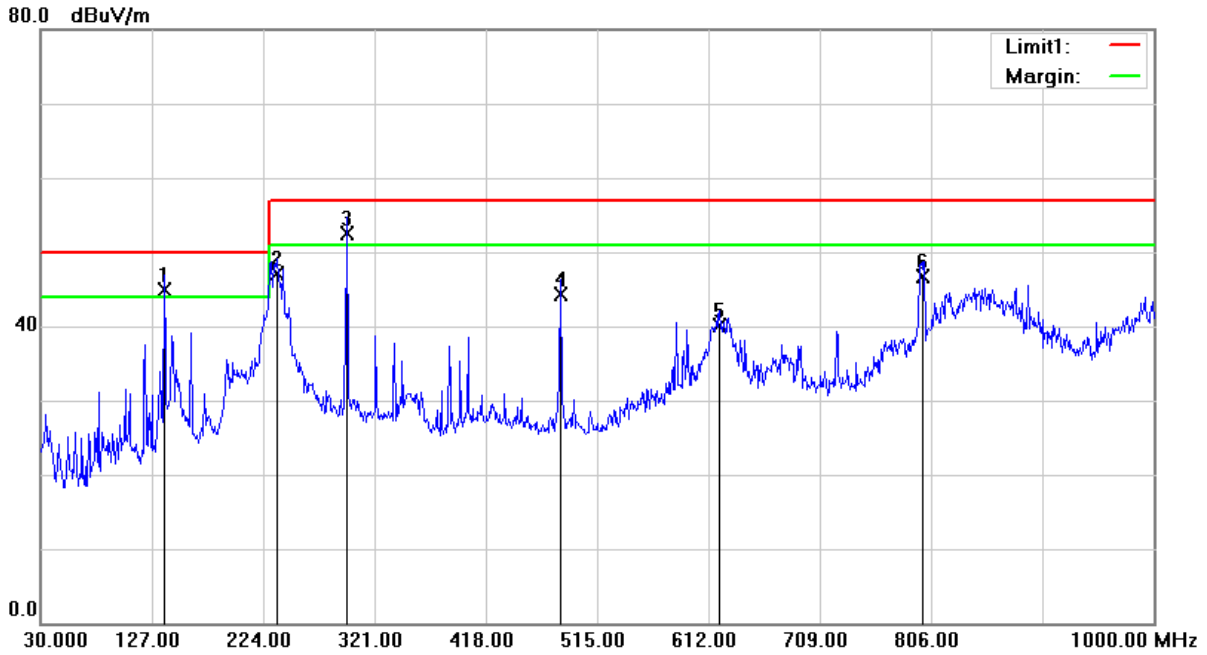

No.	Frequency (MHz)	Reading Level (dBµV)	Correct Factor (dB/m)	Measurement (dBµV/m)	Limit (dBµV/m)	Margin (dB)	Table Degree (degree)	Antenna Height (cm)	Detector
1	137.6700	54.97	-10.15	44.82	50.00	-5.18	272	200	QP
2	236.6100	58.25	-11.17	47.08	57.00	-9.92	80	100	QP
3	296.7500	61.05	-8.45	52.60	57.00	-4.40	144	100	QP
4	482.9900	47.58	-3.29	44.29	57.00	-12.71	222	200	QP
5	621.7000	39.57	0.56	40.13	57.00	-16.87	360	100	QP
6	798.2400	42.66	4.10	46.76	57.00	-10.24	134	100	QP

Remark: 1. QP = Quasi Peak
 2. Correct Factor = Antenna Factor + Cable Loss (Antenna to Pre-Amplifier) – Pre-Amplifier Gain + Cable Loss (Pre-Amplifier to Receiver)
 3. Measurement Value = Reading Level + Correct Factor
 4. Margin Level = Measurement Value – Limit Value



Test Voltage	230Vac, 50Hz	Frequency Range	1 ~ 6 GHz
Environmental Conditions	22°C, 50% RH	6dB Bandwidth	1MHz
Test Date	2024/11/27	Test Distance	3m
Tested by	Karwin Kao	Polarization	Vertical
Test Site	W08-966-1		

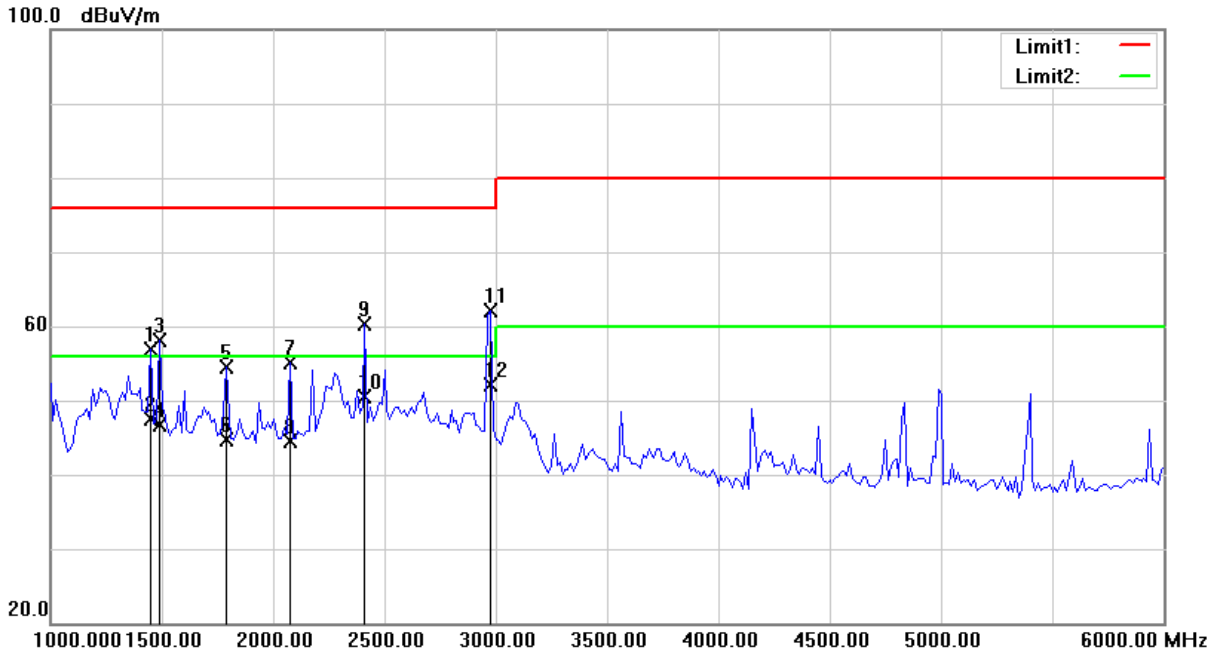

No.	Frequency (MHz)	Reading Level (dBμV)	Correct Factor (dB/m)	Measurement (dBμV/m)	Limit (dBμV/m)	Margin (dB)	Table Degree (degree)	Antenna Height (cm)	Detector
1	1450.000	75.33	-18.39	56.94	76.00	-19.06	152	100	peak
2	1450.000	65.80	-18.39	47.41	56.00	-8.59	152	100	AVG
3	1487.500	76.81	-18.70	58.11	76.00	-17.89	33	100	peak
4	1487.500	65.46	-18.70	46.76	56.00	-9.24	33	100	AVG
5	1787.500	73.00	-18.55	54.45	76.00	-21.55	177	100	peak
6	1787.500	63.32	-18.55	44.77	56.00	-11.23	177	100	AVG
7	2075.000	71.75	-16.58	55.17	76.00	-20.83	133	100	peak
8	2075.000	61.09	-16.58	44.51	56.00	-11.49	133	100	AVG
9	2412.500	75.46	-15.24	60.22	76.00	-15.78	218	100	peak
10	2412.500	65.78	-15.24	50.54	56.00	-5.46	218	100	AVG
11	2975.000	75.64	-13.47	62.17	76.00	-13.83	158	100	peak
12	2975.000	65.49	-13.47	52.02	56.00	-3.98	158	100	AVG

Remark: 1. peak = Peak, AVG = Average
 2. Correct Factor = Antenna Factor + Cable Loss (Antenna to Pre-Amplifier) – Pre-Amplifier Gain + Cable Loss (Pre-Amplifier to Receiver)
 3. Measurement Value = Reading Level + Correct Factor
 4. Margin Level = Measurement Value – Limit Value



Test Voltage	230Vac, 50Hz	Frequency Range	1 ~ 6 GHz
Environmental Conditions	22°C, 50% RH	6dB Bandwidth	1MHz
Test Date	2024/11/27	Test Distance	3m
Tested by	Karwin Kao	Polarization	Horizontal
Test Site	W08-966-1		

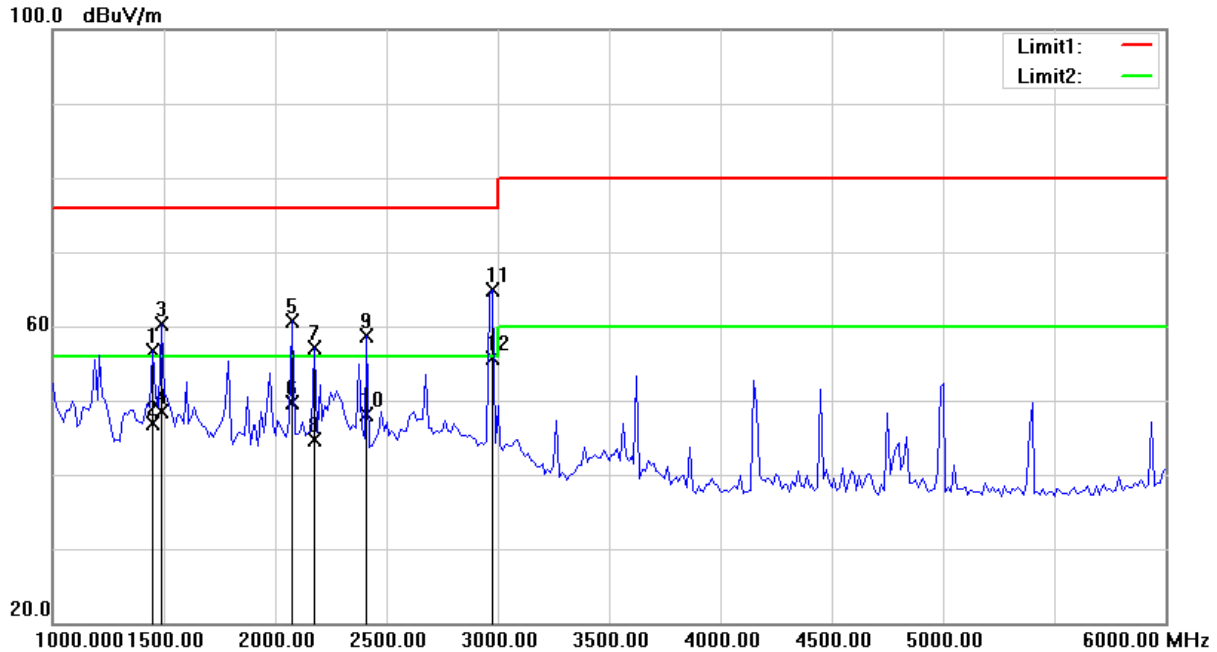

No.	Frequency (MHz)	Reading Level (dBµV)	Correct Factor (dB/m)	Measurement (dBµV/m)	Limit (dBµV/m)	Margin (dB)	Table Degree (degree)	Antenna Height (cm)	Detector
1	1450.000	75.18	-18.39	56.79	76.00	-19.21	254	100	peak
2	1450.000	65.21	-18.39	46.82	56.00	-9.18	254	100	AVG
3	1487.500	78.96	-18.70	60.26	76.00	-15.74	8	100	peak
4	1487.500	67.21	-18.70	48.51	56.00	-7.49	8	100	AVG
5	2075.000	77.19	-16.58	60.61	76.00	-15.39	345	100	peak
6	2075.000	66.29	-16.58	49.71	56.00	-6.29	345	100	AVG
7	2175.000	72.65	-15.47	57.18	76.00	-18.82	225	100	peak
8	2175.000	60.11	-15.47	44.64	56.00	-11.36	225	100	AVG
9	2412.500	73.97	-15.24	58.73	76.00	-17.27	194	100	peak
10	2412.500	63.29	-15.24	48.05	56.00	-7.95	194	100	AVG
11	2975.000	78.42	-13.47	64.95	76.00	-11.05	327	100	peak
12	2975.000	69.24	-13.47	55.77	56.00	-0.23	327	100	AVG

Remark: 1. peak = Peak, AVG = Average
 2. Correct Factor = Antenna Factor + Cable Loss (Antenna to Pre-Amplifier) – Pre-Amplifier Gain + Cable Loss (Pre-Amplifier to Receiver)
 3. Measurement Value = Reading Level + Correct Factor
 4. Margin Level = Measurement Value – Limit Value

4.2.7 Photographs of Measurement Configuration

Frequency Range: 30 MHz ~ 1 GHz



Frequency Range: Above 1 GHz



4.3 Harmonic Current Measurement

4.3.1 Limit of Harmonic Current Measurement

Limit for Class A equipment	
Harmonic Order <i>n</i>	Max. permissible harmonics current A
Odd harmonic	
3	2.30
5	1.14
7	0.77
9	0.40
11	0.33
13	0.21
$15 \leq n \leq 39$	$0.15*(15/n)$
Even harmonic	
2	1.08
4	0.43
6	0.30
$8 \leq n \leq 40$	$0.23*(8/n)$

Limit for Class D equipment		
Harmonic Order <i>n</i>	Max. permissible harmonics current per watt mA/W	Max. permissible harmonics current A
Odd Harmonic only		
3	3.4	2.30
5	1.9	1.14
7	1.0	0.77
9	0.5	0.40
11	0.35	0.33
13	0.30	0.21
$15 \leq n \leq 39$	$3.85/n$	$0.15*(15/n)$

- Note:** 1. Class A and Class D are classified according to item section 5 of EN IEC 61000-3-2.
 2. According to section 7 of EN IEC 61000-3-2, the above limits for all equipment except for Class B or C equipment and no limits apply for equipment with a rated power of 75W or less.

4.3.2 Measurement Instrument

Item	Equipment	Manufacturer	Model	Meter No.	Calibration Date
1	Harmonic & Flicker Analyzer	EMC PARTNER	HAR-1000-1P	CT-1-090(1)	Oct. 17, 2024
2	Power Source	APC	AFV-P-5000B	CT-1-210	Oct. 17, 2024

- Note:** 1. The calibration interval of the above test instruments is 12 months.

4.3.3 Measurement Procedure

The table-top equipment under test was placed on the top of a wooden table 0.8 meter above the ground and operated to produce the maximum harmonic under normal operating conditions for each successive harmonic component in turn. The floor-standing equipment under test was placed insulation support unit from the horizontal ground plane.

The classification of equipment is according to section 5 of EN IEC 61000-3-2.

The equipment is classified as follows:

Class A:

Equipment not specified as belonging to Class B, C or D shall be considered as Class A equipment.

Some example of Class A equipment are:

- Balanced three-phase equipment;
- Household appliances, excluding those specified as belonging to Class B, C or D;
- Vacuum cleaners;
- High pressure cleaners;
- Tools, excluding portable tools;
- Independent phase control dimmers;
- Audio equipment;
- Professional luminaires for stage lighting and studios.

Class B:

- Portable tools;
- Arc welding equipment which is not professional equipment.

Class C:

- Lighting equipment;
- Integrated lamps, integrated luminaires, non-integrated luminaires, separate lighting control gear;
- Lighting part of multi-function equipment where one the primary function of this is illumination;
- Ultraviolet (UV) and infrared (IR) radiation equipment;
- Illuminated advertising signs;
- Independent dimmers, other than phase control type, for lighting equipment;
- DLT control device.

Class D:

Equipment having a specified power less than or equal to 600W, of the following types:

- Personal computers and personal computer monitors;
- Television receivers;
- Refrigerators and freezers having one or more variable-speed drives to control compressor motor(s).

4.3.4 Deviation from Standard

No deviation

4.3.5 Measurement Configuration

< Table-Top equipment under test >

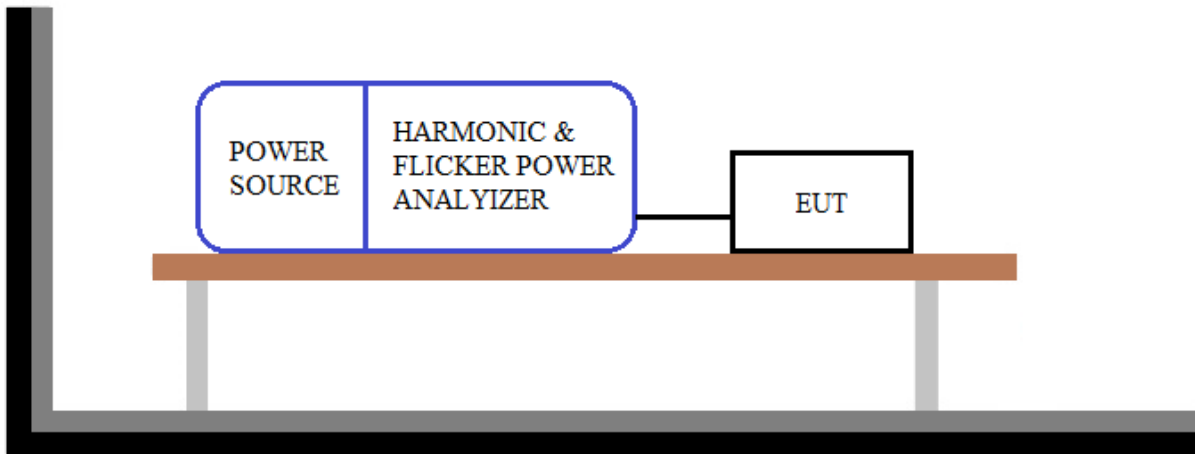

< Floor-Standing equipment under test >

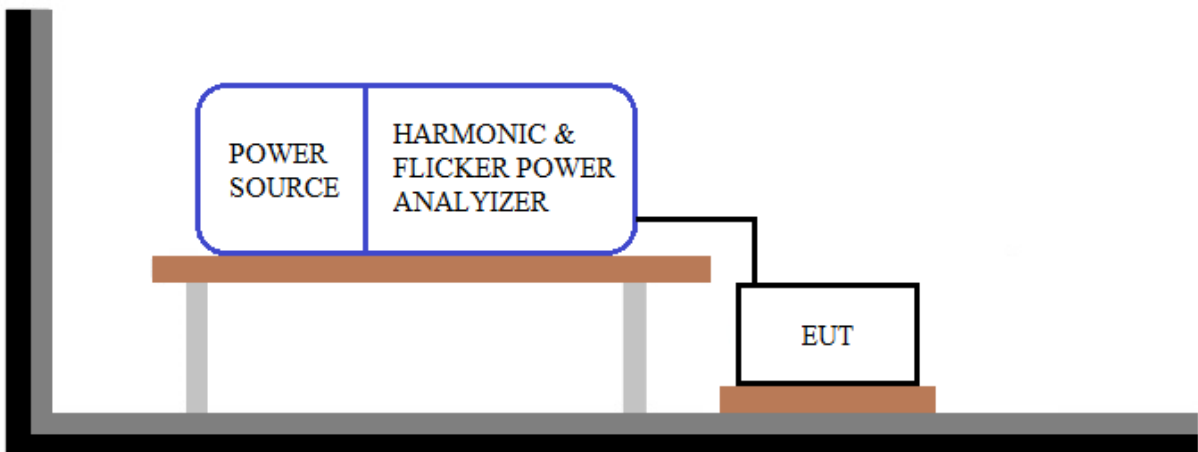



4.3.6 Measurement Result

Supply Voltage / Ampere	229.7 V _{rms} / 0.215 A _{rms}	Test Date	2024/10/21
Test Duration	5 min	Power Consumption	40.37W
Power Frequency	50.013Hz	Power Factor	0.818
Environmental Conditions	22 °C, 52% RH	Tested by	Eric Hsieh

Note:

1. Limits are not specified for equipment with a rated power of 75W or less.
2. According to EN IEC 61000-3-2 the manufacturer shall specify the power of the apparatus. This value shall be used for establishing limits. The specified power shall be within +/-10% of the measured power.

4.3.7 Photographs of Measurement Configuration

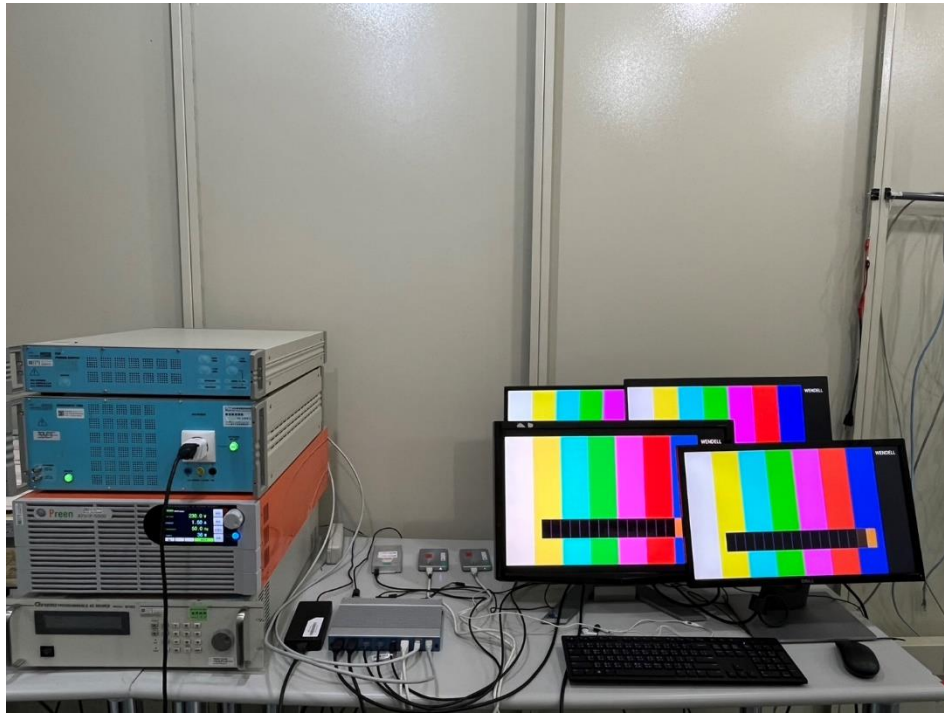

4.4 Voltage Fluctuations and Flicker Measurement

4.4.1 Limit for Voltage Functions and Flicker Measurement

Tests Item	Limits	Remark
	IEC/EN 61000-3-3	
P_{st}	1.0, $T_p=10$ min.	P_{st} means short-term flicker indicator.
P_{lt}	0.65, $T_p=2$ hr.	P_{lt} means long-term flicker indicator.
d_c (%)	3.3%	d_c means relative steady-state voltage change.
d_{max} (%)	4%	d_{max} means maximum relative voltage change.
T_{dt} (ms)	500 ms	T_{dt} means maximum time that $d(t)$ exceeds 3.3 %.

4.4.2 Measurement Instrument

Item	Equipment	Manufacturer	Model	Meter No.	Calibration Date
1	Harmonic & Flicker Analyzer	EMC PARTNER	HAR-1000-1P	CT-1-090(1)	Oct. 17, 2024
2	Power Source	APC	AFV-P-5000B	CT-1-210	Oct. 17, 2024

Note: 1. The calibration interval of the above test instruments is 12 months.

4.4.3 Measurement Procedure

The table-top equipment under test was placed on the top of a wooden table 0.8 meter above the ground and operated to produce the most unfavorable sequence of voltage changes under normal operating condition. The floor-standing equipment under test was placed insulation support unit from the horizontal ground plane.

During the flick measurement, the measure time shall include that part of whole operation cycle in which the EUT produce the most unfavorable sequence of voltage changes. The observation period for short-term flicker indicator is 10 min and the observation period for long-term flicker indicator is 2 hours.

4.4.4 Deviation from Standard

No deviation

4.4.5 Measurement Configuration

< Table-Top equipment under test >

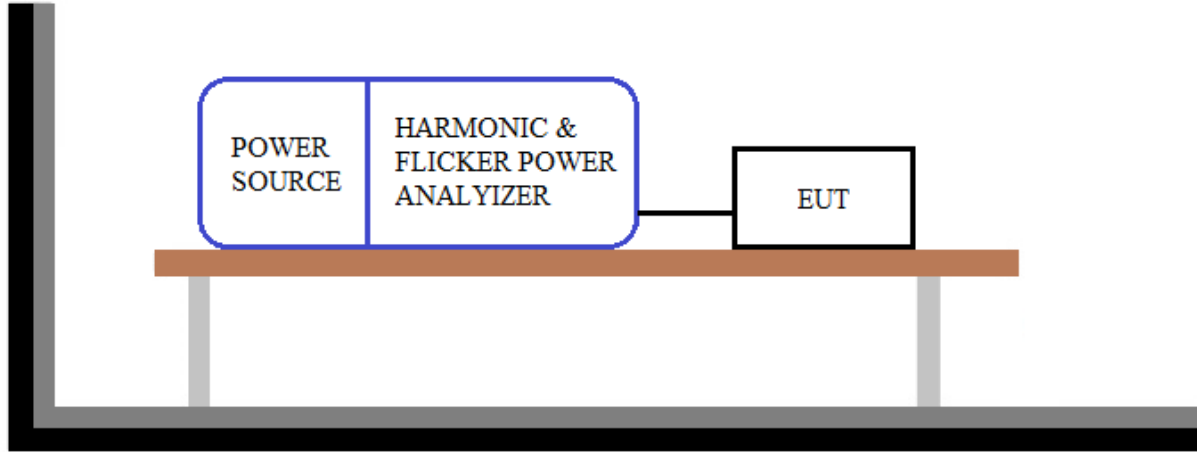

< Floor-Standing equipment under test >

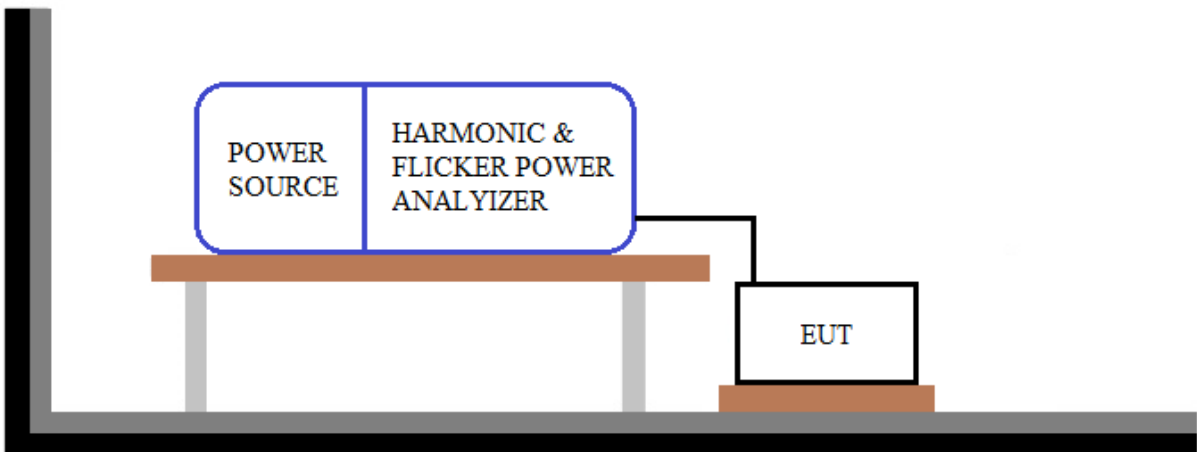



4.4.6 Measurement Result

Supply Voltage / Ampere	229.5 Vrms / 0.203 Arms	Test Date	2024/10/21
Observation (Tp)	30 min	Environmental Conditions	22 °C, 52% RH
Power Frequency	50.000Hz	Tested by	Eric Hsieh

Test Parameter	Measurement Value	Test Limit	Remarks
P_{st}	0.07	1.00	Pass
P_{lt}	0.07	0.65	Pass
T_{dt} (ms)	0.00	500	Pass
d_{max} (%)	0.00	4%	Pass
d_c (%)	0.02	3.3%	Pass

- Note:**
1. P_{st} means short-term flicker indicator.
 2. P_{lt} means long-term flicker indicator.
 3. T_{dt} means maximum time that dt exceeds 3.3 %.
 4. d_{max} means maximum relative voltage change.
 5. d_c means relative steady-state voltage change.

4.4.7 Photographs of Measurement Configuration

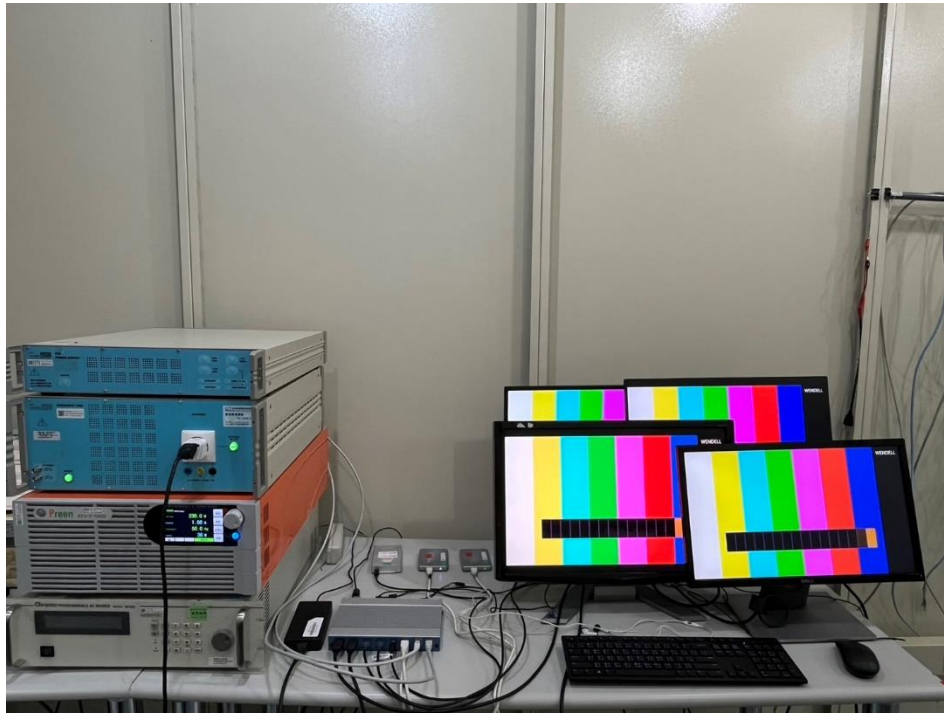

5 Immunity Test

5.1 Standard Description

Product standard	EN 50121-3-2	
Basic Standard and Performance Criterion required	EN 61000-4-2 (ESD)	Contact discharge: ± 6 kV, Air discharge: ± 8 kV Performance Criterion B
	EN IEC 61000-4-3 (RS)	Field Strength: 20 V/m ^(Note1, 2) , 10 V/m, 5 V/m, 3 V/m Test Signal: 80% AM with 1 kHz sine wave Frequency Range: 80 M ~ 1000 MHz, 1400 MHz ~ 2000 MHz, 2000 MHz ~ 2700 MHz, 5100 MHz ~ 6000 MHz Performance Criterion A
	EN 61000-4-4 (EFT)	Power Port: ± 2 kV Signal / Control Port (cable length > 3m): ± 2 kV Performance Criterion A
	EN 61000-4-5 (Surge)	Power Port - Line to Line: ± 1 kV, 42 Ω , 0.5 μ F Line to Ground: ± 2 kV, 42 Ω , 0.5 μ F Performance Criteria B
	EN IEC 61000-4-6 (CS)	Voltage Level: 10V Test Signal: 80% AM with 1 kHz sine wave Frequency Range: 0.15 M ~ 80 MHz Applicable to port: Power Port, Signal / Control Port Performance Criterion A

Note 1: This limit applies to equipment mounted in the passenger compartments, drivers cab or external to the rolling stock (roof, underframe). For equipment mounted in all other areas a severity level of 10V/m may be used.

Note 2: For large apparatus (e.g. traction drives, auxiliary converters) it is often not practical to perform the immunity test to radiated electromagnetic fields on the complete unit. In such cases the manufacturer should test susceptible sub-systems (e.g. control electronics). The test report should justify the selection or not of sub-systems and any assumptions made (e.g. reduction of field due to case shielding).

5.2 Performance Criteria

According to EN 50121-1 standard, the general performance criteria as following:

Criteria A	The apparatus shall continue to operate as intended during and after the test. No degradation of performance or loss of function is allowed below a performance level specified by the manufacturer, when the apparatus is used as intended. The performance level may be replaced by a permissible loss of performance. If the minimum performance level or the permissible performance loss is not specified by the manufacturer, either of these may be derived from the product description and documentation, and from what the user may reasonably expect from the apparatus if used as intended.
Criteria B	The apparatus shall continue to operate as intended after the test. No degradation of performance or loss of function is allowed below a performance level specified by the manufacturer, when the apparatus is used as intended. The performance level may be replaced by a permissible loss of performance. During the test, degradation of performance is however allowed. No change of actual operating state or stored data is allowed. If the minimum performance level or the permissible performance loss is not specified by the manufacturer, either of these may be derived from the product description and documentation, and from what the user may reasonably expect from the apparatus if used as intended.
Criteria C	Temporary loss of function is allowed, provided the function is selfrecoverable or can be restored by the operation of the controls.

5.3 Electrostatic Discharge Immunity Test

5.3.1 Test Specification

Standard	EN 61000-4-2
Discharge Impedance	330 ohm / 150 pF
Discharge Voltage	Air Discharge: ± 2 kV, ± 4 kV, ± 8 kV (Direct) Contact Discharge: ± 6 kV (Direct/Indirect)
Number of Discharge	Air: Minimum 10 times at each polarity Contact: Minimum 10 times at each polarity
Discharge Mode	Single Discharge
Discharge Period	1 second minimum

5.3.2 Test Instrument

Item	Equipment	Manufacturer	Model	Meter No.	Calibration Date
1	ESD Generator	TESEQ	NSG 437	CT-1-140	Jun. 15, 2024
2	ESD Generator	NoiseKen	ESS-B3011	CT-1-089	Jul. 23, 2024
3	Digital Thermo-Hygro Meter	N/A	HTC-8	CT-2-047	Jun. 06, 2023
4	Atmosphere pressure meter	TES	TES-1161	CT-5-094	Aug. 10, 2023

- Note:**
1. The calibration interval of the test instruments is 12 months.
 2. The calibration interval of thermo hygrometer/ Atmosphere pressure meter is 24 months.

5.3.3 Test Procedure

The test procedure was in accordance with IEC 61000-4-2.

The test generator necessary to perform direct and indirect application of discharge to the equipment under test in following methods:

a. Contact discharges to the conductive surface and coupling planes:

For table-top equipment under test one of the test points shall be the centre front edge of the horizontal coupling plane, which shall be subjected to at least 20 indirect discharges (10 of each polarity).

All other test points shall each receive at least 20 direct contact discharges (10 of each polarity).

All surfaces normally touched by the user should be tested. Test shall be performed at a maximum repetition rate of one discharge per second.

Vertical Coupling Plane (VCP):

The coupling plane, of dimensions 0.5 m × 0.5 m, is placed parallel to, and positioned at a distance 0.1 m from the equipment under test, with the discharge electrode touching the coupling plane. The four faces of the equipment under test will be performed with electrostatic discharge.

Horizontal Coupling Plane (HCP):

The coupling plane, of dimensions 1.6 m × 0.8 m, is placed under the equipment under test. The generator shall be positioned vertically a distance of 0.1 m from the equipment under test, with the discharge electrode touching the coupling plane. The four faces of the equipment under test will be performed with electrostatic discharge.

b. Air discharge at apertures and slots and insulating surface:

On those surfaces of the equipment under test where it is not possible to perform contact discharge testing, the equipment should be investigated to identify user accessible points where breakdown may occur. Such points are tested using the air discharge method. This investigation should be restricted to those area normally handled by the user. A minimum 20 single air discharges (10 of each polarity) shall be applied to the selected test point for each such area.

5.3.4 Deviation from Standard

No deviation

5.3.5 Test Configuration

< Table-Top equipment under test >

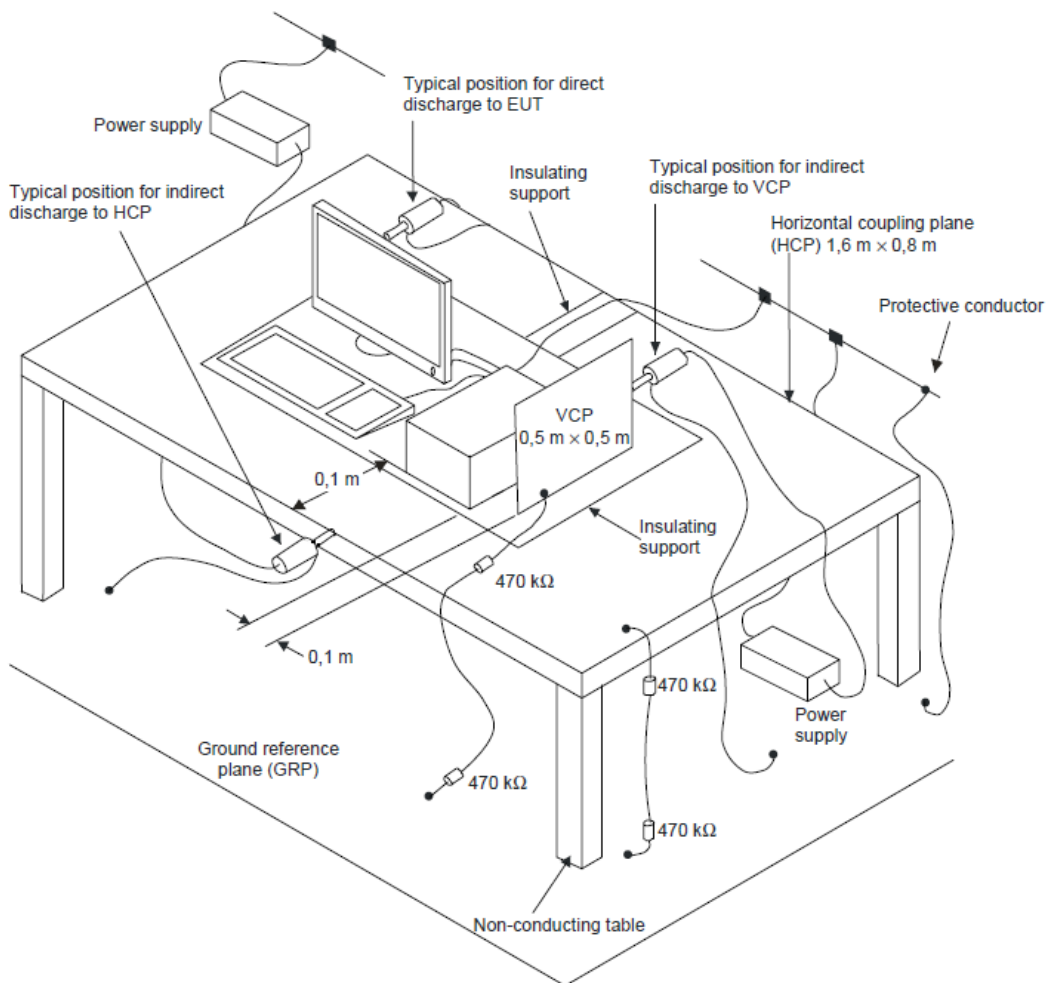

< Floor-Standing equipment under test >

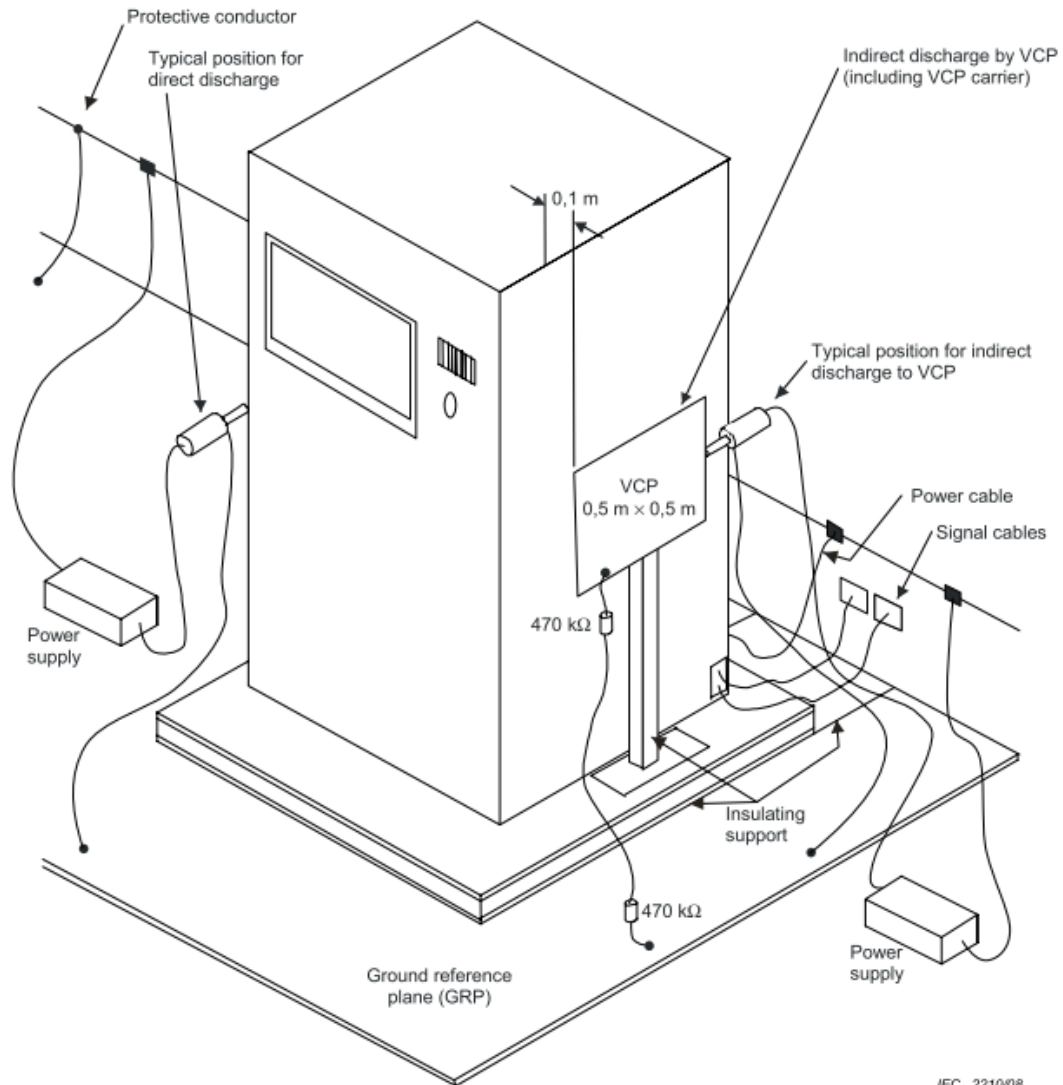



5.3.6 Test Result

Test Voltage	230Vac, 50Hz	Test Date	2024/12/02
Environmental Conditions	21°C, 51% RH	Pressure	1008 mbar
Tested by	Guanwei Liao	Test Site	W01

Test Results of Direct Application

Air Discharge				
Test Point	Discharge Level (kV)			Result
	±2	±4	±8	
Front	NA	NA	NA	NA
Back	A	A	A	A
Left	NA	NA	NA	NA
Right	NA	NA	NA	NA
Top	NA	NA	NA	NA
Bottom	NA	NA	NA	NA
Other	NA	NA	NA	NA

* Test location(s) in which discharge to be applied illustrated by photos shown in next page(s).

Contact Discharge		
Test Point	Discharge Level (kV)	Result
	±6	
Front	B (#1)	B
Back	B (#1)	B
Left	B (#1)	B
Right	B (#1)	B
Top	B (#1)	B
Bottom	B (#1)	B
Other	NA	NA

* Test location(s) in which discharge to be applied illustrated by photos shown in next page(s).

Test Results of Indirect Application

HCP Discharge		
Test Point	Discharge Level (kV)	Result
	± 6	
Front	A	A
Back	A	A
Left	A	A
Right	A	A

VCP Discharge		
Test Point	Discharge Level (kV)	Result
	± 6	
Front	A	A
Back	A	A
Left	A	A
Right	A	A

Note:

Criteria A: The EUT function was correct during the test.

Criteria A: (#1) No occur arcing.

Criteria B: (#1) The EUT was interrupted during the test, but could self-recover to the normal mode after the test.

Description of Test Points

Front



Back



*Red Dot - Contact Discharged
Blue Dot - Air Discharged

Left

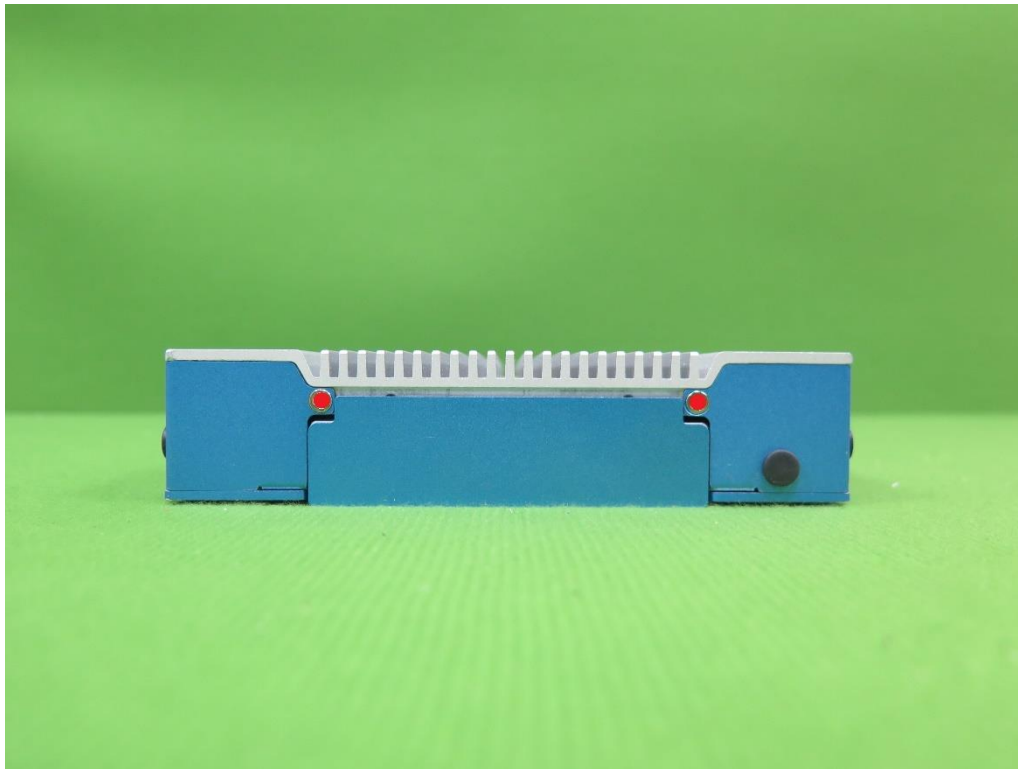

Right

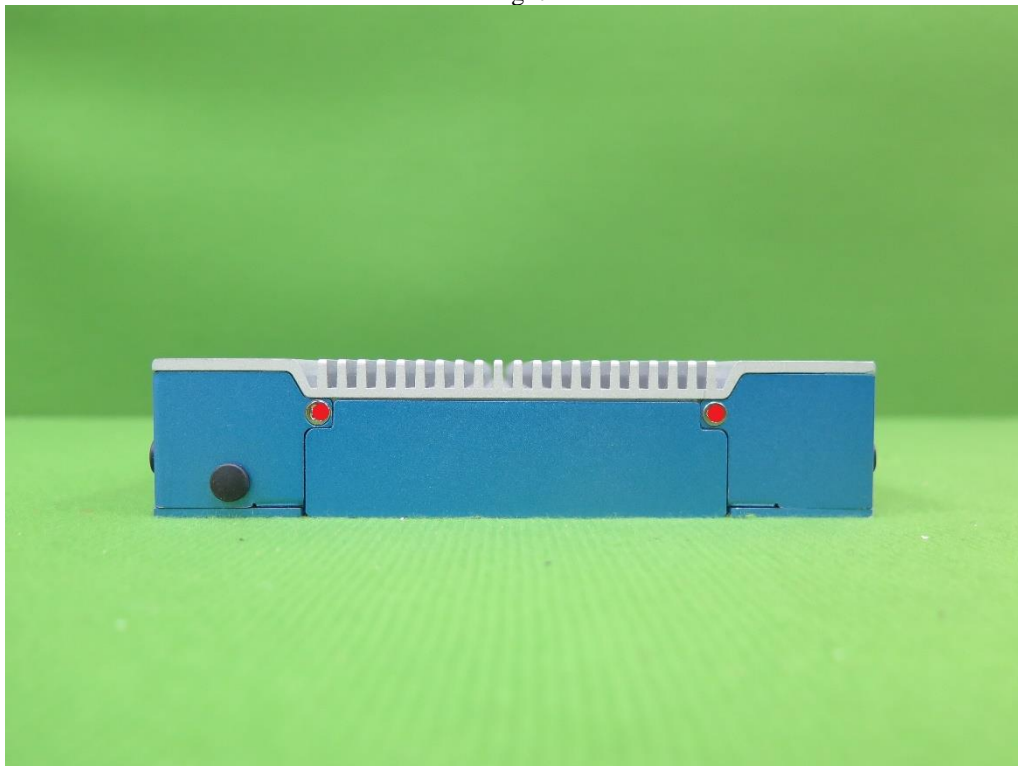

*Red Dot - Contact Discharged
Blue Dot - Air Discharged

Top



Bottom

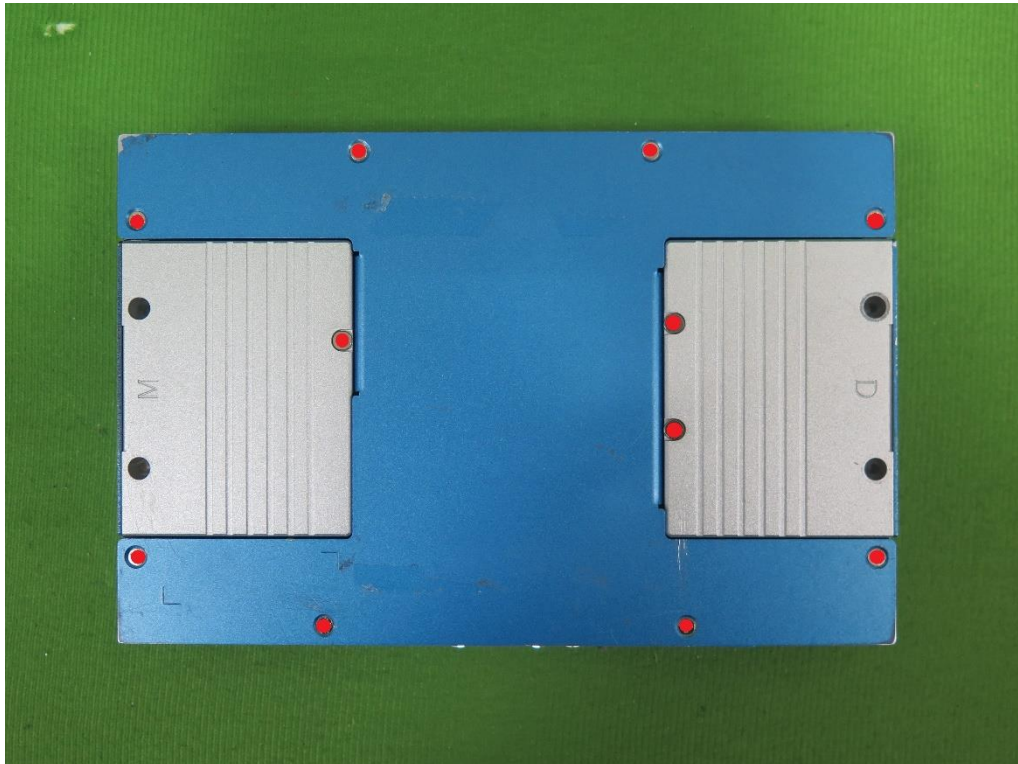

*Red Dot - Contact Discharged
Blue Dot - Air Discharged

5.3.7 Photographs of Test Configuration



5.4 Radiated, Radio-frequency Electromagnetic Field Immunity Test

5.4.1 Test Specification

Standard	EN IEC 61000-4-3
Frequency Range / Field Strength	80 MHz ~ 800 MHz: 20 V/m ^(Note1) 800 MHz ~ 1000 MHz: 20 V/m 1400 MHz ~ 2000 MHz: 10 V/m 2000 MHz ~ 2700 MHz: 5 V/m 5100 MHz ~ 6000 MHz: 3 V/m
Modulation	80% AM Modulation with 1 kHz Sine Wave
Frequency Step	1%
Polarity of Antenna	Horizontal and Vertical
Test Distance	2.15 m (80 MHz ~ 1000 MHz) 1 m (1 GHz ~ 6 GHz)
Antenna Height	1.55 m (80 MHz ~ 1000 MHz) 1.05 m (1 GHz ~ 6 GHz)
Dwell Time	3 seconds

Note 1: This limit applies to equipment mounted in the passenger compartments, drivers cab or external to the rolling stock (roof, underframe). For equipment mounted in all other areas a severity level of 10 V/m may be used.

5.4.2 Test Instrument

Item	Equipment	Manufacturer	Model	Meter No.	Calibration Date
1	RadiCentre ® Modular EMC Test Systems	DARE	CTR1004B	CT-1-080	No calibration request
2	RF Signal Generator	DARE	RGN6000B	CT-1-080	Aug. 06, 2024
3	LINEAR POWER RF AMPLIFIER	TESEQ	CBA1G-300 D	CT-1-163	Aug. 06, 2024
4	LINEAR POWER RF AMPLIFIER	OPHIR	5193	CT-1-083	Aug. 06, 2024
5	LINEAR POWER RF AMPLIFIER	FRANKONIA	FLG-30C	CT-1-061	Aug. 06, 2024
6	Periodic Test-Antenna	Schwarzbeck Mess - Elektronik	STLP 9128 E	CT-1-085	No calibration request
7	Stacked Microwave Log.-Per. Antenna	Schwarzbeck Mess - Elektronik	STLP 9149	CT-1-086	No calibration request
8	Electric Field Probe	FRANKONIA	EFS-10	CT-1-060a1	Sep. 29, 2024
9	Measurement Software	EMC-RS	Ver: 2.0.1.3	N/A	No calibration request

Note: 1. The calibration interval of the above test instruments is 12 months.

5.4.3 Test Procedure

The test procedure was in accordance with IEC 61000-4-3.

- a. The table-top equipment under test and load, which are placed on a table that is 0.8 meter above ground, are placed with one coincident with the Uniform Field Area (UFA) such that the distance from antenna to the EUT was 2.15 meter at test frequency 80M ~ 1GHz & 1 meter at test frequency 1G ~ 6GHz. Both horizontal and vertical polarization of the antenna and four sides of the equipment under test are set on measurement. All cables shall be connected to the equipment under test and arranged on the test site in accordance with the installation instructions and shall replicate typical installations and use as much as possible.
- b. The specified wiring types and connectors shall be used. If the wiring to and from the equipment under test is not specified, unshielded parallel conductors shall be used. If the product specification require a wiring length of less than or equal to 1 m, then the specified length shall be used. If the length specified is greater than 1 m, or is not specified, then the length of cable used shall be chosen in accordance with typical installation practices. Unless otherwise specified above, a minimum of 1 m of cable shall be exposed to the electromagnetic field in one orientation, either vertical or horizontal.
- c. Each cable does not need to be exposed to the field during the exposure of each face of the equipment under test. But each cable shall, at least during one of the equipment under test orientations, be positioned within the Uniform Field Area (UFA), and thus exposed to the field.
- d. If a product committee determines excess cable length needs to be decoupled (for cables leaving the test area), then the decoupling method used shall not impair the operation of the equipment under test. If cable decoupling is performed, CMADs may be used. The CMAD shall always be placed flat on the floor. Each cable to be decoupled should be treated with a separate CMAD.
- e. If the equipment under test is too large such that it cannot be fully illuminated by the radiating antenna, or exceeds the size of the Uniform Field Area (UFA) then partial illumination shall be used. The equipment under test can be repositioned so that the front surface remains within the Uniform Field Area (UFA) in order to illuminate those sections of the equipment under test that were previously outside the Uniform Field Area (UFA).
- f. The frequency range shall be swept, with the signal 80% amplitude modulated with a 1kHz sine wave. If multiple test signals were used during testing, care should be taken to ensure that any recorded performance degradation was caused by a single test signal and was not caused by the combination of multiple test signals.

5.4.4 Deviation from Standard

No deviation

5.4.5 Test Configuration

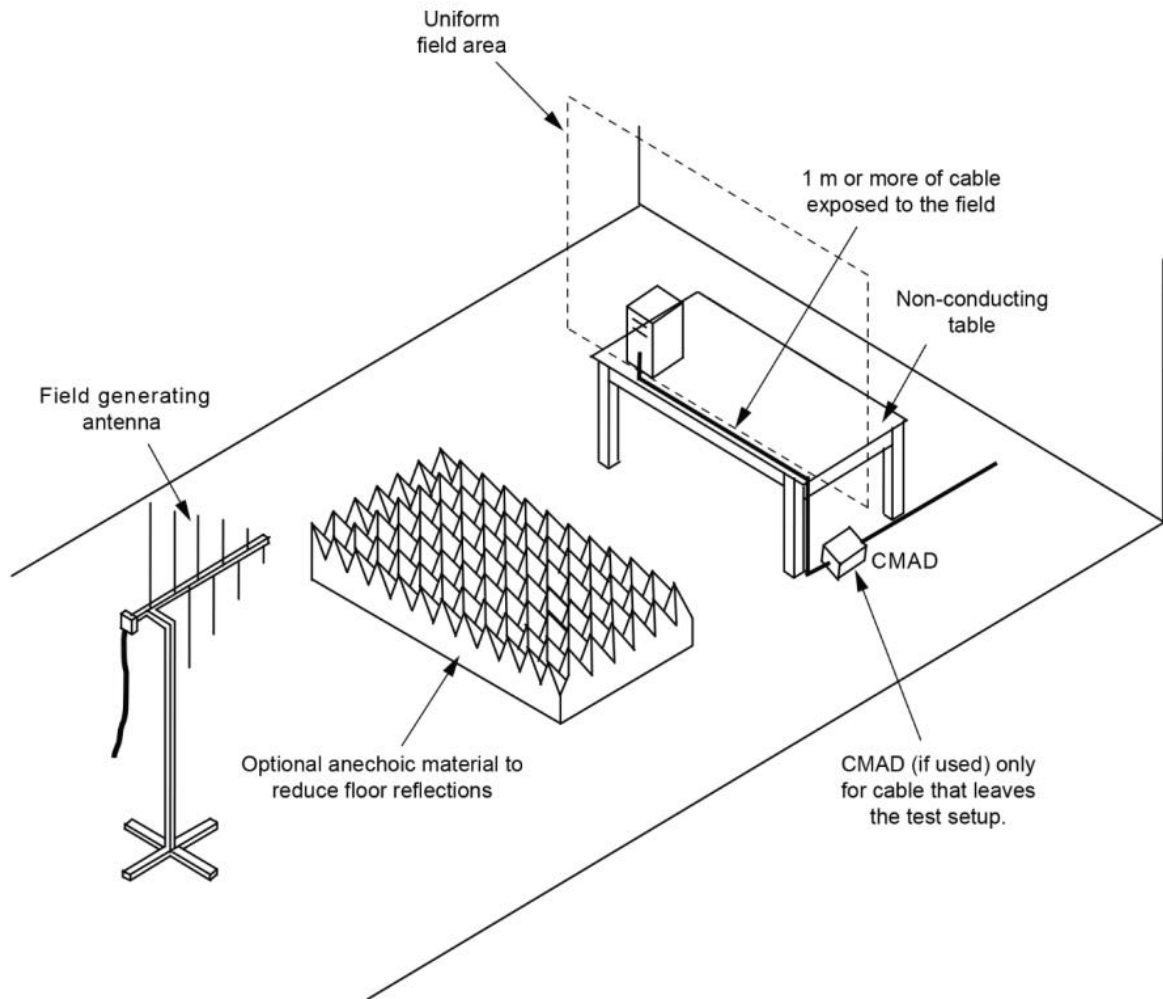



5.4.6 Test Result

Test Voltage	230Vac, 50Hz	Environmental Conditions	22°C, 50% RH
Tested by	Alan Chung	Test Date	2024/11/22

Frequency Range (MHz)	Azimuth	Polarity	Field Strength (V/m)	Modulation	Result
80 ~ 1000	0	H/V	20	80% AM (1kHz)	A
80 ~ 1000	90	H/V	20	80% AM (1kHz)	A
80 ~ 1000	180	H/V	20	80% AM (1kHz)	A
80 ~ 1000	270	H/V	20	80% AM (1kHz)	A

Frequency Range (MHz)	Azimuth	Polarity	Field Strength (V/m)	Modulation	Result
1400 ~ 2000	0	H/V	10	80% AM (1kHz)	A
1400 ~ 2000	90	H/V	10	80% AM (1kHz)	A
1400 ~ 2000	180	H/V	10	80% AM (1kHz)	A
1400 ~ 2000	270	H/V	10	80% AM (1kHz)	A

Frequency Range (MHz)	Azimuth	Polarity	Field Strength (V/m)	Modulation	Result
2000 ~ 2700	0	H/V	5	80% AM (1kHz)	A
2000 ~ 2700	90	H/V	5	80% AM (1kHz)	A
2000 ~ 2700	180	H/V	5	80% AM (1kHz)	A
2000 ~ 2700	270	H/V	5	80% AM (1kHz)	A

Frequency Range (MHz)	Azimuth	Polarity	Field Strength (V/m)	Modulation	Result
5100 ~ 6000	0	H/V	3	80% AM (1kHz)	A
5100 ~ 6000	90	H/V	3	80% AM (1kHz)	A
5100 ~ 6000	180	H/V	3	80% AM (1kHz)	A
5100 ~ 6000	270	H/V	3	80% AM (1kHz)	A

Note:

Criteria A: The EUT function was correct during the test.

5.4.7 Photographs of Test Configuration



5.5 Electrical Fast Transient /Burst Immunity Test

5.5.1 Test Specification

Standard	EN 61000-4-4
Test Voltage	Power Port: ± 2 kV Signal / Control Port (cable length > 3m): ± 2 kV
Polarity	Positive & Negative
Impulse Frequency	5 kHz
Impulse Wave	5/50 ns
Burst Duration	15 ms
Burst Period	300 ms
Test Duration	Not less than 1 min.

5.5.2 Test Instrument

Item	Equipment	Manufacturer	Model	Meter No.	Calibration Date
1	EFT Generator	3ctest	EFT500S	CT-1-165	Sep. 27, 2024
2	Clamp	3ctest	CCC100	CT-1-166	Sep. 27, 2024

Note: 1. The calibration interval of the above test instruments is 12 months.

5.5.3 Test Procedure

The test procedure was in accordance with IEC 61000-4-4.

- a. The table-top equipment under test was placed on a table that is 0.8 meter height. A ground reference plane is placed on the table, and uses 0.1 m insulation between the equipment under test and ground reference plane. The floor-standing equipment under test was placed on 0.1 m insulation support unit between the equipment under test and ground reference plane.
- b. The minimum area of the ground reference plane is 1 m × 1 m, and 0.65 mm thick min, and projected beyond the equipment under test by at least 0.1 m on all sides. The equipment under test shall be arranged and connected to satisfy its functional requirements, according to the equipment installation specifications.

For input power ports:

The equipment under test is connected to the power ports through a coupling device that directly couples the EFT/B interference signal. Each of the line conductors is impressed with burst noise for 1 minute. The distance between the coupling device and the table-top equipment under test is 0.5 m.

For signal / data ports:

The capacitive coupling clamp shall be used for the application of the test voltages. The test voltages shall be coupled to all of the equipment under test ports in turn including those between two units of equipment involved in the test, unless the length of the interconnecting cable makes it impossible to test.

5.5.4 Deviation from Standard

No deviation

5.5.5 Test Configuration

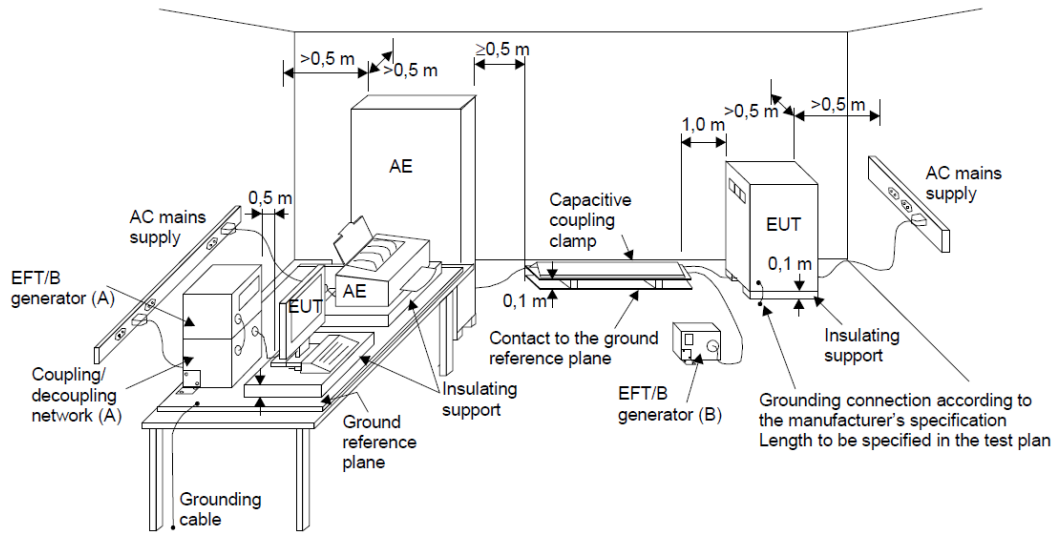

- (A) location for supply line coupling
- (B) location for signal lines coupling

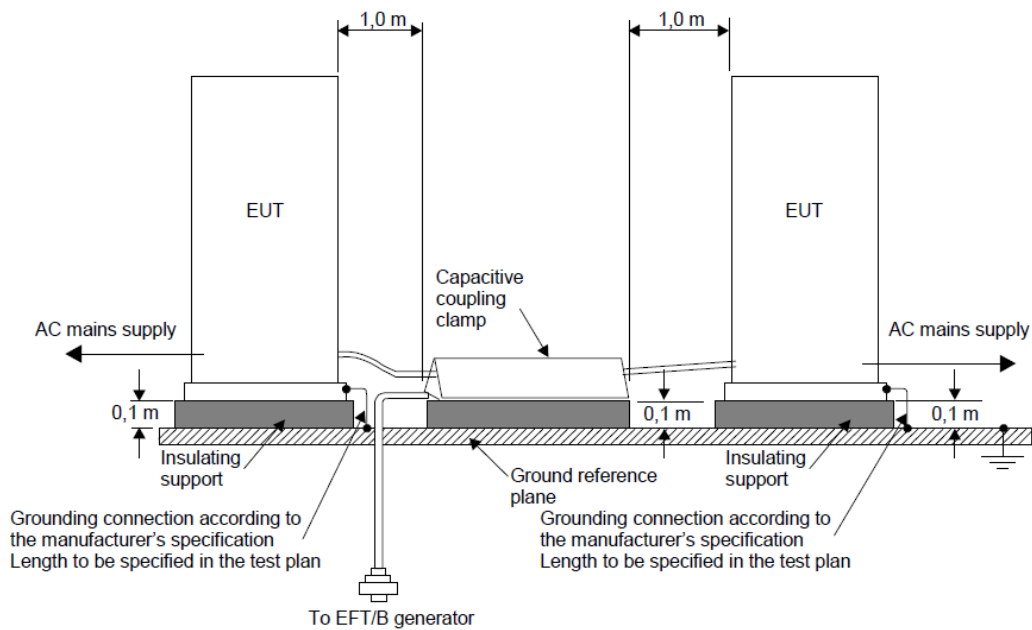



5.5.6 Test Result

Test Voltage	230Vac, 50Hz	Environmental Conditions	25°C, 54% RH
Tested by	Eric Hsieh	Test Date	2024/10/21

Test Point		Test Level (kV)	Polarity (+/-)	Result
AC Power Port	L	2	+/-	A
	N	2	+/-	A
	PE	2	+/-	A
	L + N	2	+/-	A
	L + PE	2	+/-	A
	N + PE	2	+/-	A
	L + N + PE	2	+/-	A
Signal and communication, process measurement and control ports	LAN	2	+/-	A

Note:

Criteria A: The EUT function was correct during the test.

5.5.7 Photographs of Test Configuration

Power



Signal



5.6 Surge Immunity Test

5.6.1 Test Specification

Standard	EN 61000-4-5
Wave- Shape	Combination Wave 1.2/50 μ s Open Circuit Voltage, 8/20 μ s Short Circuit Current
Test Voltage	Power Port - Line to Line: ± 1 kV, 42 Ω , 0.5 μ F Line to Ground: ± 2 kV, 42 Ω , 0.5 μ F
Polarity	Positive/Negative
Phase Angle	0°/90°/180°/270° (For AC Main Power Port)
Pulse Repetition Rate	1 time / min. (maximum)
Times	5 Positive and 5 Negative at selected points

5.6.2 Test Instrument

Item	Equipment	Manufacturer	Model	Meter No.	Calibration Date
1	Surge Generator	HAEFELY	AXOS8	CT-1-059(1)	Aug. 12, 2024
2	Surge CDN	3cTest	CDN-405T8A1	CT-1-074(5)	May 27, 2024

Note: 1. The calibration interval of the above test instruments is 12 months.

5.6.3 Test Procedure

The test procedure was in accordance with IEC 61000-4-5.

- a. The table-top equipment under test was placed on a table that is 0.8 meter height. A ground reference plane is placed on the table, and uses 0.1m insulation between the equipment under test and ground reference plane.
- b. If not otherwise specified the power cord between the EUT and the coupling network shall not exceed 2 m in length.

For input power ports:

The table-top equipment under test was connected to the power ports through a coupling device that directly couples the surge interference signal. The surge noise shall be applied synchronized to the peak value of the voltage wave (Positive and negative). Each of Line to Earth and Line to Line is impressed with a sequence of five surge voltages with interval of 1 minute.

For signal / data ports:

The table-top equipment under test was connected to the signal ports of associated equipment through a Coupling / De-coupling Network (CDN). The surge noise shall be applied synchronized to the peak value of the voltage wave (Positive and negative). Each of Line to Earth is impressed with a sequence of five surge voltages with interval of 1 minute.

For shielded lines:

The table-top equipment under test is isolated from ground and the surge is applied to its metallic enclosure; the termination (or auxiliary equipment) at the port under test is grounded. The length of the cable between the port under test and the device attached to the other end of the cable shall be 20 m (preferred length) or, the shortest length over 10 m, where the manufacturer provides pre-assembled cables used in actual installations. For EUTs which do not have metallic enclosures, the surge is applied directly to the shielded cable at the EUT side.

No test shall be required for cables which according to the manufacturer's specification are ≤ 10 m.

5.6.4 Deviation from Standard

No deviation

5.6.5 Test Configuration

< Table-Top equipment under test >

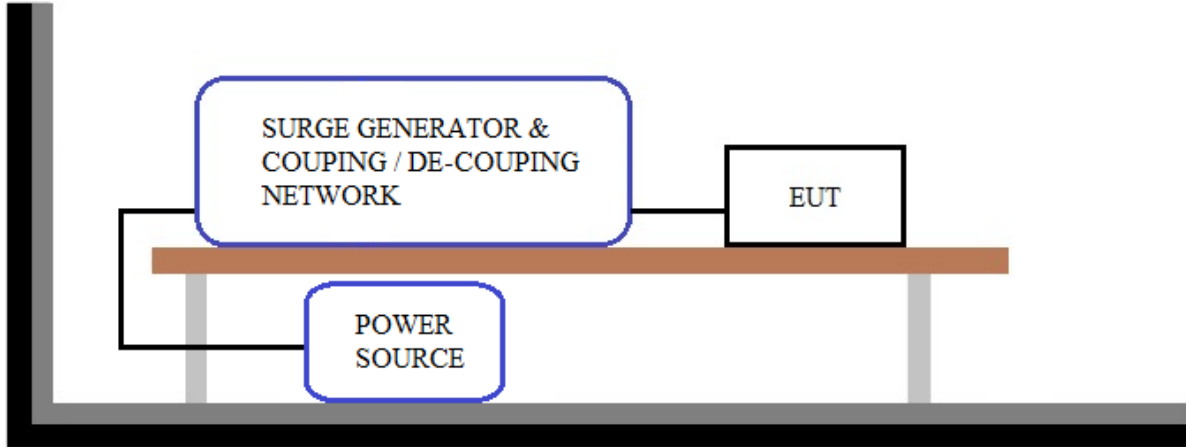

< Floor-Standing equipment under test >

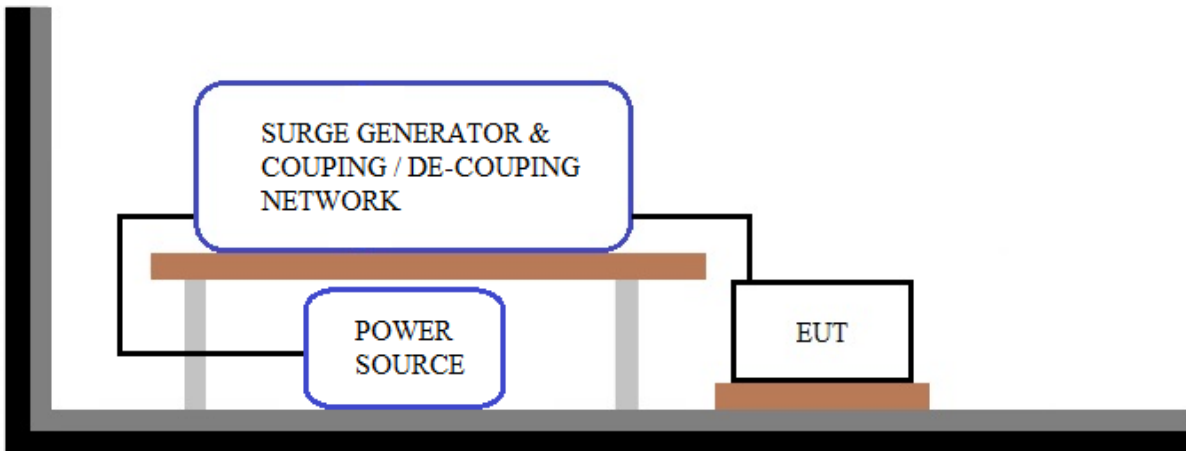



5.6.6 Test Result

Test Voltage	230Vac, 50Hz	Environmental Conditions	22°C, 51% RH
Tested by	Guanwei Liao	Test Date	2024/12/02
Test Site	W01		

AC Power Port						
Test Point	Phase	Polarity (+/-)	Test Voltage (kV)			Result
			0.5	1	2	
L to N	0°	+/-	A	A	-	A
	90°	+/-	A	A	-	
	180°	+/-	A	A	-	
	270°	+/-	A	A	-	
L to PE	0°	+/-	A	A	A	A
	90°	+/-	A	A	A	
	180°	+/-	A	A	A	
	270°	+/-	A	A	A	
N to PE	0°	+/-	A	A	A	A
	90°	+/-	A	A	A	
	180°	+/-	A	A	A	
	270°	+/-	A	A	A	

Note:

Criteria A: The EUT function was correct during the test.

5.6.7 Photographs of Test Configuration

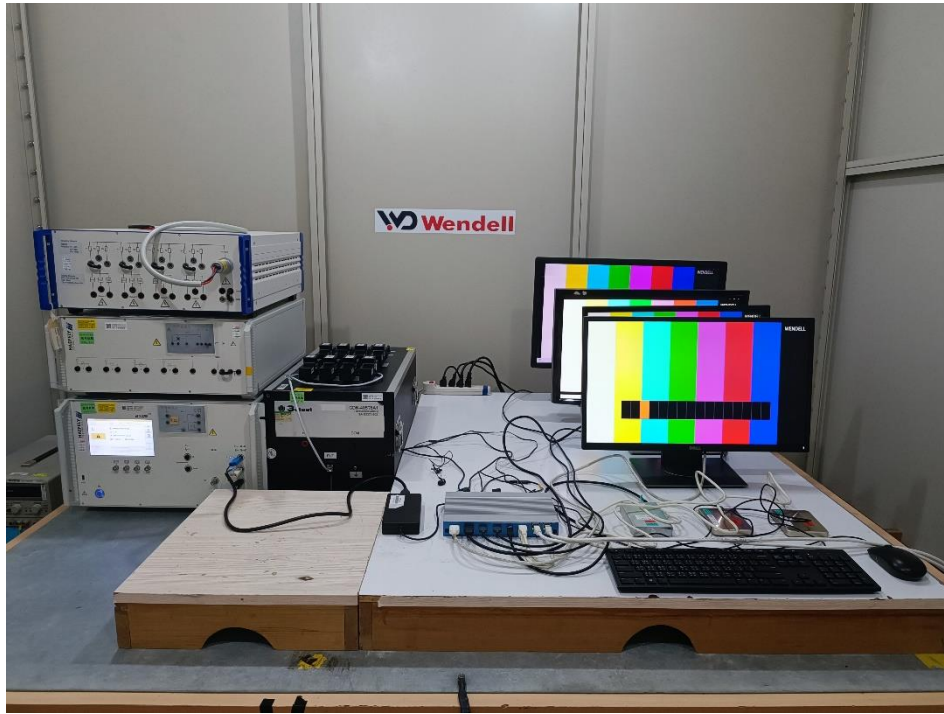



5.7 Conducted Disturbances Immunity Test

5.7.1 Test Specification

Standard	EN IEC 61000-4-6
Frequency Range	0.15 MHz ~ 80 MHz
Voltage Level	10 V
Modulation	80% AM Modulation with 1 kHz Sine Wave
Frequency Step	1%
Dwell Time	3 seconds

5.7.2 Test Instrument

Item	Equipment	Manufacturer	Model	Meter No.	Calibration Date
1	Coupling clamp according to IEC 6100-4-6	FRANKONIA	EMCL-20	CT-1-049	May 30, 2024
2	CDN for power supply lines	FRANKONIA	CDN M2+M3	CT-1-054	May 30, 2024
3	6 dB Attenuator	BIRD	75-A-FFN-06	CT-1-056	May 30, 2024
4	Compact Immunity Test System acc	FRANKONIA	CIT-10/75	CT-1-057	May 30, 2024
5	CDN for screened lines	FRANKONIA	RJ45S	CT-1-052 (1)	May 30, 2024
6	50ohm Termination	N/A	N/A	CT-1-065-1	May 30, 2024
7	CDN Four Balanced Pairs-unscreened	Com-Power	CDN-T8E	CT-1-130	May 30, 2024
8	Measurement Software	HUBERT	Ver: 1.1.2	N/A	No calibration request

Note: 1. The calibration interval of the above test instruments is 12 months.

5.7.3 Test Procedure

The test procedure was in accordance with IEC 61000-4-6.

- a. The table-top equipment under test was placed on an insulating support of 0.1 m height above a reference ground plane. If the equipment is designed to be mounted in a panel, rack or cabinet, then it shall be tested in this configuration. Grounding of the equipment shall be consistent with the EUT's installation instructions. The Coupling/De-coupling Network (CDN) shall be located between 0.1 m and 0.3 m from the equipment under test.
- b. The frequency range shall be swept, using the signal level established during the setting process and with a disturbance signal of 80 % amplitude. The signal is modulated with a 1 kHz sine wave, pausing to adjust the RF signal level or the switch coupling devices as necessary. Where the frequency is swept incrementally, the step size shall not exceed 1 % of the preceding frequency value.

For input power ports:

The table-top equipment under test was connected to the power ports through a Coupling/De-coupling Network (CDN) for power supply lines. And directly couples the disturbances signal into equipment under test.

For signal / data ports:

The table-top equipment under test was connected to the signal ports of associated equipment through a Coupling/De-coupling Network (CDN). And directly couples the disturbances signal into equipment under test.

5.7.4 Deviation from Standard

No deviation

5.7.5 Test Configuration

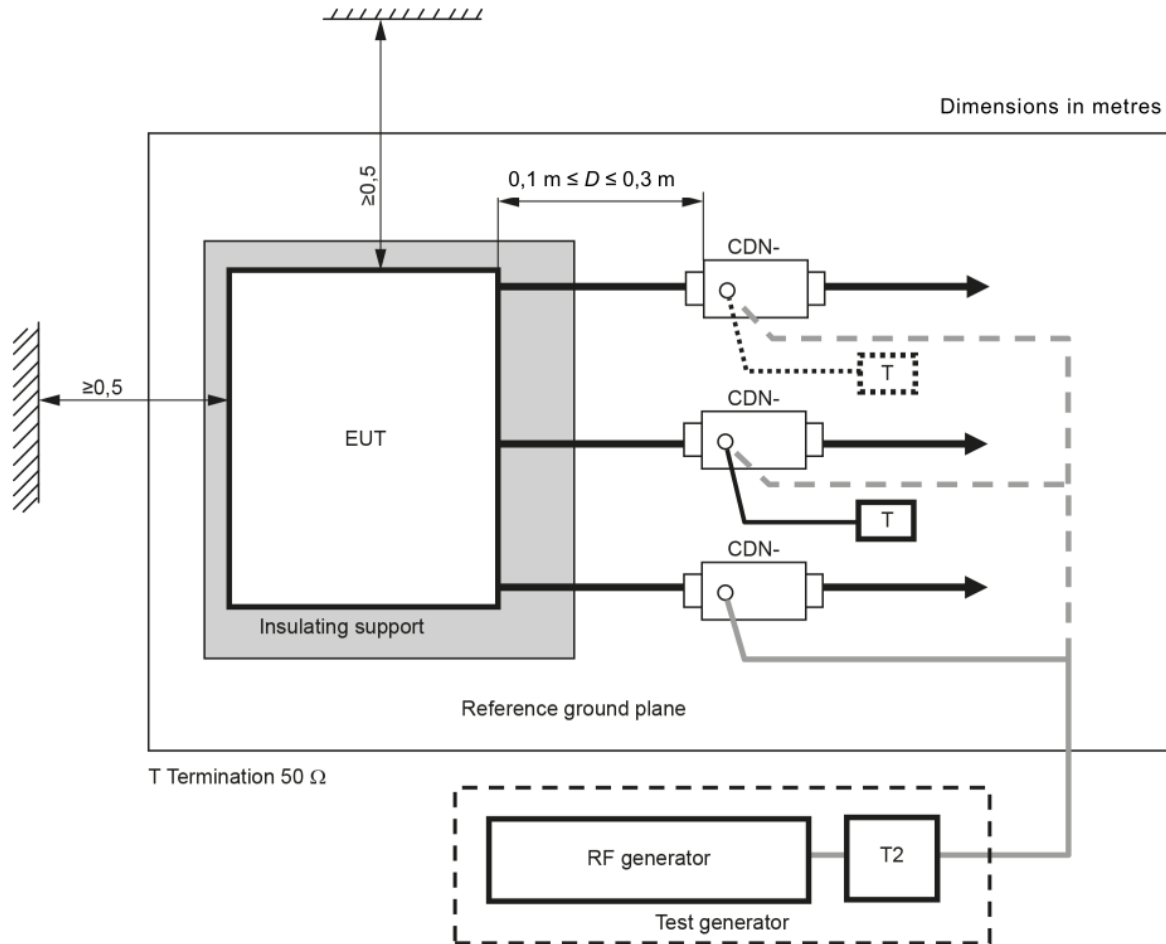

Note:

1. The EUT clearance from any metallic objects other than test equipment shall be at least 0,5 m.
2. Only one of the CDNs not used for injection shall be terminated with 50 Ω, providing only a single return path. All other CDNs shall be configured as decoupling networks.



5.7.6 Test Result

Test Voltage	230Vac, 50Hz	Environmental Conditions	25°C, 54% RH
Tested by	Eric Hsieh	Test Date	2024/10/23

Frequency Range (MHz)	Tested Port	Injection Method	Test Level (V_{r.m.s.})	Modulation	Result
0.15 ~ 80	AC Power	CDN-M2 +M3 (M3)	10	80% AM, 1kHz	A
0.15 ~ 80	LAN	CDN RJ45/S	10	80% AM, 1kHz	A

Note:

Criteria A: The EUT function was correct during the test.

5.7.7 Photographs of Test Configuration

Power

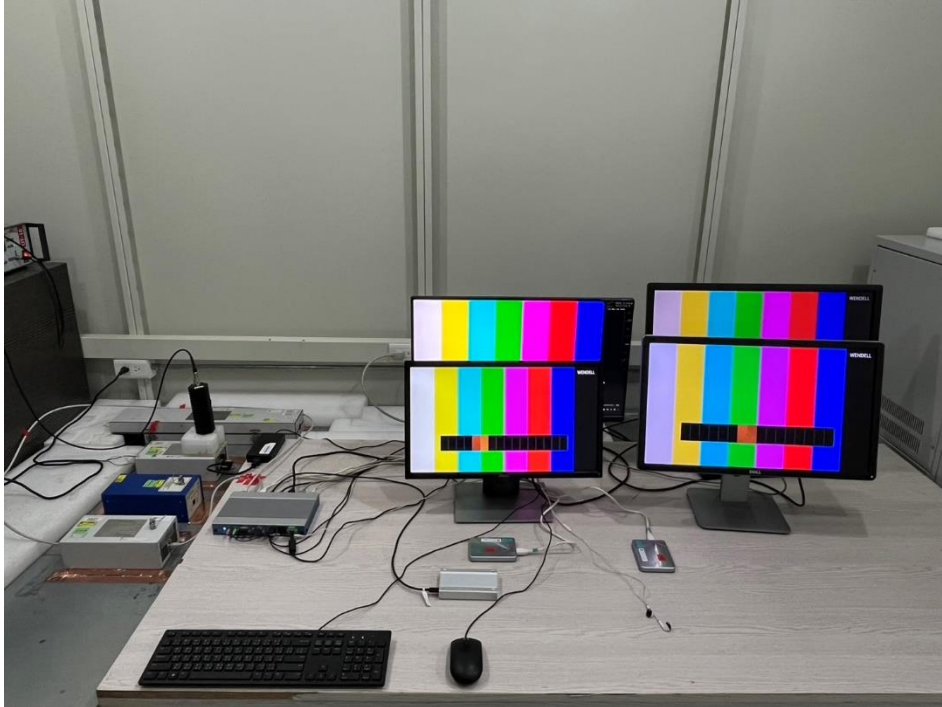

Signal

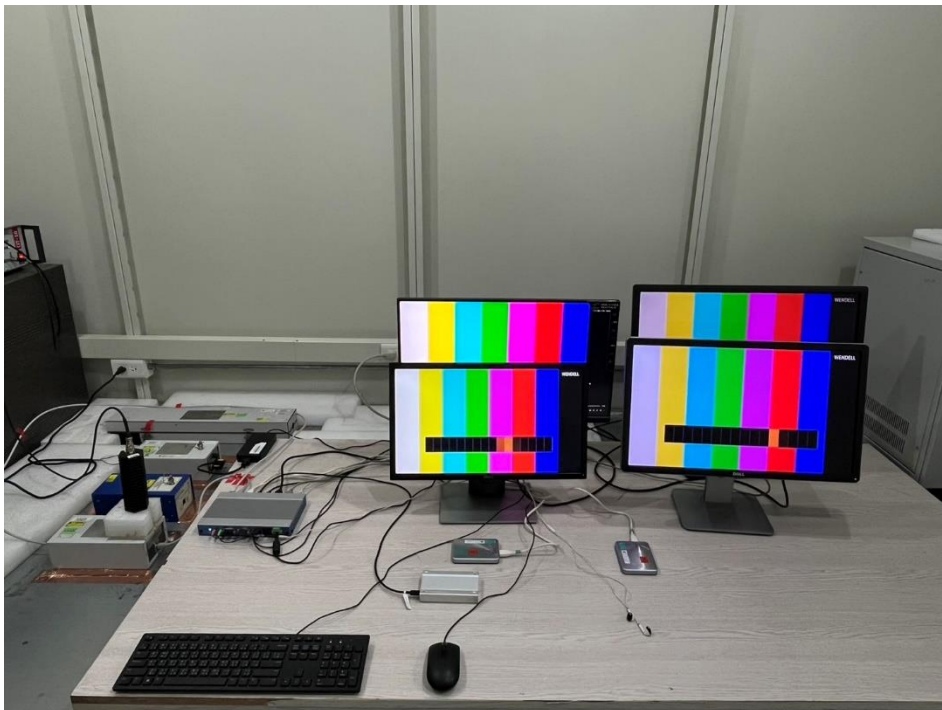

< End Page >